

CALIMET

GATE ACCESS CONTROL SYSTEMS

M9-2

SWING LINEAR ARMS OPERATOR

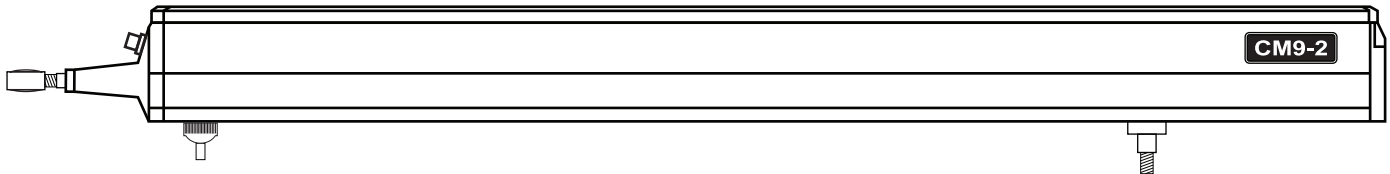

INSTALLATION AND OWNER MANUAL

WWW.CALIMETCO.COM

9949 HAYWARD WAY, SOUTH EL MONTE, CA 91733

TEL: 626.452.9009

V.3.1 | 2023.06.01

TABLE OF CONTENTS

OVERVIEW	GATE OPERATOR OVERVIEW	01
	SAFETY	02 - 03
	PROPERTY TYPE AND ENTRAPMENT PROTECTION	04
<hr/>		
INSTALLATION	PREINSTALLATION	05
	CONTROL BOX INSTALLATION	06
	LINEAR ARM INSTALLATION	07 - 10
	ARM POSITIONING GUIDANCE	11
	CIRCUIT BOARD LAYOUT	12
	DIP SWITCH FEATURES	13
	CONTROL BOX WIRING	14
	POWER CONNECTION	15
	GATE OPEN DIRECTION SETTINGS	16
	DUAL GATE WIRING AND SETUP	17
	PHOTOCELL SENSOR INSTALLATION	18
	PHOTOCELL SENSOR LED INDICATORS	19
	SECONDARY PHOTOCELL SENSOR (OPTIONAL)	20
	PHYSICAL LIMITS ADJUSTMENT	21
	FORCE ADJUSTMENT	22
	WARNING SIGNS INSTALLATION	23
	EMERGENCY RELEASE LOCK	24
	AFTER INSTALLATION	25
<hr/>		
ACCESSORIES	REMOTE CONTROLS	26
WIRING	VEHICLE LOOP DETECTORS	27 - 29
	ACCESSORY WIRING	30 - 32
<hr/>		
IMPORTANT	CIRCUIT BOARD LIGHT STATUS CHART	33
INFORMATION	TROUBLESHOOTING	34
	MAINTENANCE	35
	MANUFACTURER'S LIMITED WARRANTY	36
	IMPORTANT INFORMATION AND NOTES	37

GATE OPERATOR OVERVIEW

POWER INPUT	110 - 120V AC, CM9-2-DCFP/DCFP-S: 7 AMPS
SYSTEM OPERATION VOLTAGE	CM9-2-DCFP: 24V DC
MAXIMUM OUTPUT CURRENT	7 AMPS, FUSE 24V DC 7 AMPS
DIMENSIONS	CONTROL BOX: (L x W x H) LINEAR ARM: (L x W x H)
GATE TYPE	SWING LINEAR ARM
APPLICATION	RESIDENTIAL / COMMERCIAL
MAXIMUM GATE WEIGHT	1600 LBS
MAXIMUM GATE LENGTH	18 FEET
OPERATING TEMPERATURE	-4°F TO 140°F
MAXIMUM GATE TRAVEL SPEED	APPROXIMATELY 20 SEC FOR 90° OPENING (ADJUSTABLE)
MAXIMUM DUTY CYCLE	CONTINUOUS
INHERENT ENTRAPMENT PROTECTION	INHERENT REVERSE SENSOR SYSTEM (TYPE A)
EXTERNAL ENTRAPMENT PROTECTION	PHOTOELECTRIC SENSOR (TYPE B1)
SOLAR READY	CM9-2-DCNB: NO, CM9-2-DCFP/DCFP-S: YES
EMERGENCY RELEASE	KEY
PROPERTY CLASS	I, II, III, IV
WARRANTY	RESIDENTIAL: 5 YEARS, COMMERCIAL: 3 YEARS
WHAT'S IN THE BOX	<p>CM9-2-DCNB PACKAGE</p> <p>CONTROL BOX (1), SWING LINEAR ARM (1), CM9-864 CONTROL (2), PHOTOSENSOR AND REFLECTOR (1), PHOTOSENSOR MOUNT (2), WARNING SIGN (2), NUTS AND BOLTS (1), MOUNTING HARDWARE, USER MANUAL, WARRANTY CARD.</p> <p>CM9-2-DCFP PACKAGE</p> <p>CM9-2-DCNB PACKAGE, BATTERY (1), BATTERY CIRCUIT BOARD (1)</p> <p>CM9-2-DCFP-S PACKAGE</p> <p>CM9-2-DCFP PACKAGE, EXTENDED SOLAR BATTERY (1), SOLAR PANEL *2)</p>

SAFETY (MUST READ)

Carefully read follow, and accept all safety precautions and warnings before attempting to install and use gate swing linear arm operator, incorrect installation can lead to severe injury or death.

- The gate operator must be installed by a certified (licensed) gate technician; otherwise serious personal injury or property damage may occur.
- Installing a gate operator may require installation of standard 110v-120v AC electrical wiring. This work should only be performed by an experienced electrician. Miswiring could cause personal injury or death.
- Never let children operate the gate or play around the gate. Keep the remote control away from children.
- Always keep people and objects away from the gate. Cars, people, and objects should never enter when the gate is closing.
- Verify that this operator is proper for the type, weight, and size of the gate.
- Make sure the gate has been properly installed and swings freely in both directions with no resistance. Repair or replace all worn or damaged gate hardware prior to installation.
- Test gate operator monthly. The gate must reverse when it comes in contact with a solid object, or stop when an object activates the non-contact sensors. After adjusting the force or travel limit, re-test the gate operator. Failure to maintain the gate operator properly can increase the risk of injury or death.
- Use the emergency release only when the gate is not moving.
- Keep the gate and gate operator properly maintained. Read the maintenance section of this manual and follow the maintenance schedule. Have a certified service technician make repair or install gate operator hardware(s).
- Gate operator can use a huge amount of force to open and close the gate. Therefore, safety features must be taken into consideration when installing and using a gate operator. Specific safety features include: photoelectric sensors, edge sensors (contact), moving gate warning signs, guards for exposed rollers, screen mesh, vertical posts, and more.
- The gate must be installed in a location so that enough clearance is supplied between the gate and adjacent structures when opening and closing to reduce the risk of entrapment.
- Entrapment is defined as when a person, vehicle, or object is caught or held in a position that increases the risk of injury.
- Access controls intended for users must be located at least 6 feet (1.8m) away from any moving part of the gate and where the user is prevented from reaching over, under, around, or through the gate to operate the controls.

SAFETY (MUST READ)

- A minimum of two (2) warning signs shall be installed, one on each side of the gate that is easily visible.
- Gate auto closed timer function is not recommended unless loop detectors are installed.
- The gate must have sufficient room when opening and closing. Swinging gates should open inwards and not into public access areas. The gate must be properly installed and move freely in both directions.
- Install the gate operator only when: 1) The operator is appropriate for the construction of the gate and the usage class of the gate, 2) All exposed pinch points are eliminated or guarded.
- For gate operators utilizing Type D protection: 1) The gate operator controls must be placed so that the user has full view of the gate area when the gate is moving, 2) The placard shall be placed adjacent to the controls, 3) An automatic closing device (such as timer, loop sensor, or similar devices) shall not be employed, and 4) No other activation device shall be connected.
- The gate operator is intended for installation only on vehicular gates. Pedestrians must access a separate entrance. The pedestrian entrance shall be designed for pedestrian usage. The gate must be installed in a location so that pedestrians will not come in contact with the vehicular gate during the entire path of travel of the vehicular gate.
- For gate operators utilizing a non-contact sensor, see instructions on the placement of non-contact sensors for each Type of application, 2) Care shall be exercised to reduce the risk of nuisance tripping such as when a vehicle, trips the sensor while the gate is still moving, and 3) One or more non-contact sensors shall be located where the risk of entrapment or obstruction exists, such as the perimeter reachable by a moving gate or barrier.
- For a gate operator utilizing a contact sensor: 1) one or more contact sensors shall be located at the leading edge, trailing edge, and post mounted both inside and outside of a vehicular gate. 2) One or more contact sensors shall be located at the bottom edge of a vehicular vertical lift gate. 3) One or more contact sensors shall be located at the pinch point of a vehicular vertical pivot gate. 4) A hardwired contact sensor shall be located and its wiring arranged so that the communication between the sensor and the gate operator is not subjected to mechanical damage. 5) A wireless contact sensor such as one that transmits radio frequency (RF) signals to the gate operator for entrapment protection functions shall be located where the transmission of the signals are not obstructed or impeded by building structures, natural landscaping or similar obstructions. A wireless contact sensor shall function under the intended end-use cond.
- Controls intended to be used to reset an operator after 2 sequential activations of the entrapment protection device(s) must be located in the line-of-sight of the gate. Outdoor or easily accessible controls shall have a security feature to prevent unauthorized use.

PROPERTY TYPES & ENTRAPMENT PROTECTION

Required Entrapment Protection

- A - Inherent (built-in) Entrapment Protection System
- B1 - Non-contact sensor such as a photosensor or equivalent
- B2 - Contact sensor such as edge sensor or equivalent
- C - Inherent adjustable clutch or pressure relief device
- D - Actuation device requiring continuous pressure to maintain gate motion
- E - Inherent Audio Alarm

Class I - Residential

Intended for use in a home of one (1) to four (4) single family dwellings, garage or parking area associated therewith

Swing Gate Requirements: Primary Device: A, C

Secondary Device (one required): A, B1, B2, C, D

Class II - Commercial

Intended for use in a commercial location or building such as a multi-family housing unit (five or more single family units, hotel, garages, retail store or other building servicing the general public.

Swing Gate Requirements: Primary Device: A, C

Secondary Device (one required): A, B1, B2, C, D

Class III - Industrial

Intended for use in an industrial location or building such as a factory, loading dock area, or other locations not intended to service the general public.

Swing Gate Requirements: Primary Device: A, B1, B2, C

Secondary Device (one required): A, B1, B2, D, E

Class IV - Restricted Access

Intended for use in a guarded industrial location or building such as a military base, hazardous chem sites, or other restricted access locations, in which unauthorized access is prevented via supervision by staffs.

Swing Gate Requirements: Primary Device: A, B1, B2, C, D

Secondary Device (one required): A, B1, B2, C, D, E

NOTE: A minimum of 2 independent entrapment protection devices are required for each direction of travel. The same type of device shall not be utilized for both the primary & secondary entrapment protection means. Use of a single device to cover both the opening & closing directions is in accordance with the requirement; however, a single device is not required to cover both directions.

PREINSTALLATION

Gate Structure

Confirm that the gate operator being installed is appropriate for the gate type, weight and size. The gate should be mounted and moving freely. There should be a little resistance in the movement of the gate. the gate & post must be suitable for being automated. Check that the structure is sufficiently strong & stable, and that its dimensions and weights conform to those listed in the specifications table of this document. Any worn or damaged gate hardware must be repaired or replaced before installing the gate operator.

Vehicular gates are to be constructed and installed in accordance with the ASTM F2200 construction standards.

Electricity

The CM9-2 is powered by 110v-120v AC power. IF you have not already done so, and you are not using solar power, wire a waterproof outlet near the gate following proper safety standards for your area. we're recommended hire a state licensed electrician to perform all your wiring tasks as well as wire in the CM9-2 swing linear arm. Make sure your electrician takes into account the voltage drop involved in running many feet of wire to your installation location. If an insufficient gauge of wire is used, the gate operator may have insufficient power.

The gate operator must be disconnected from the power source before the installation. This also includes gate operator accessories.

CONTROL BOX INSTALLATION

Option 1 - Mounting with Included Plastic Hinges:

1. On the back of CM9-2, locate the 4 plastic hinges attached with a Philips screw on each corner.
2. Unscrew the Philips screws and turn the plastic hinges to the desired position and angle (FIGURE A).
3. Tighten the Philips screws to secure the plastic hinges in place.
4. Position the power box on the wall where you want to mount it and mark 4 holes.
5. Drill holes and use wall anchors to mount the power box securely.

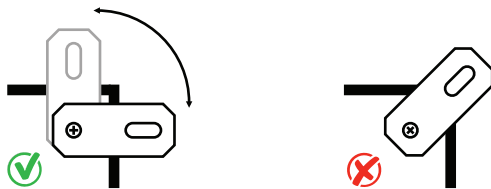

FIGURE A

Option 2 - Mounting Direct:

1. On the back of CM9-2, unscrew the 4 Philips screws and remove the 4 plastic hinges from the corners.
2. Open the power box and remove the 4 Philips screws (FIGURE B) on the baseboard to disconnect the circuit board system from the control box case.
3. Drill 4 holes from the marked location (FIGURE C) on the back of the control box case, to create a mount holes.
4. Drill holes and use wall anchors to mount the box securely, and consider using liquid shield to shield the mounting holes for added protection.
5. Reinstall the circuit board system (baseboard) back into the case and secure it with the 4 Philips screws.

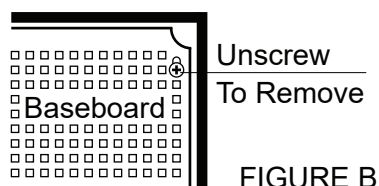

FIGURE B

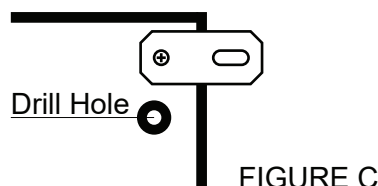

FIGURE C

LINEAR ARM INSTALLATION (OPEN INSIDE)



OPEN INSIDE

Single Gate Installation Set-up

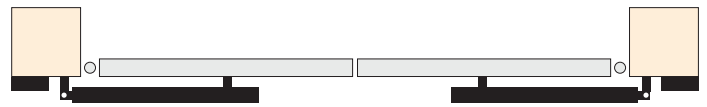

OPEN INSIDE

Double Gate Installation Set-up

1. Weld the Wall Bracket to the Wall Plate to create a stable base for the linear arm (FIGURE A).
2. Mounting the Wall Plate to the Wall: first drill holes in the desired location on the wall, and use wall anchors to securely mount the Wall Plate to the wall.
3. Use the included nut, washers, and bolt to connect the CM9-2 Linear Arm to the Wall Plate. Tighten the bolt to secure the Linear Arm to the Wall Plate (FIGURE B)
4. Position the Gate Plate to be level with the CM9-2 Linear Arm. Once everything is leveled and measured, weld the Gate Plate to the gate, and ensure that the plate covers up to 3 pickets on the gate (FIGURE C).
5. Connect the Gate Mount Bracket to the Linear Arm travel bolt. Adjust the bracket until the measurements match the suggestions on page 8.
6. Weld the Gate Bracket securely to the Gate Plate, and Verify that everything is stable and secure

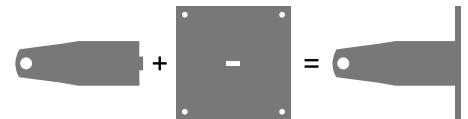

FIGURE A



FIGURE B



FIGURE C

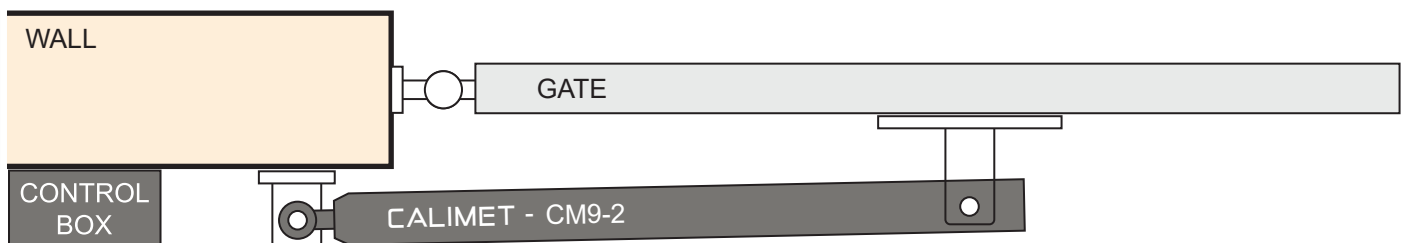

Please note that welding should be done by a professional and skilled welder to ensure safety and durability. Additionally, follow all safety guidelines and use appropriate tools and materials as specified in the product's manual or instructions.

LINEAR ARM INSTALLATION (OPEN INSIDE)

Refer to the illustrations below to determine the measurement of the swing linear arm operator.



OPEN INSIDE

Single Gate Installation Set-up

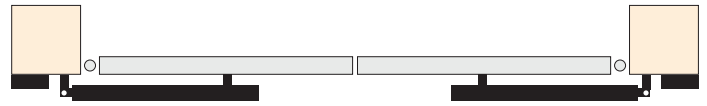

OPEN INSIDE

Double Gate Installation Set-up

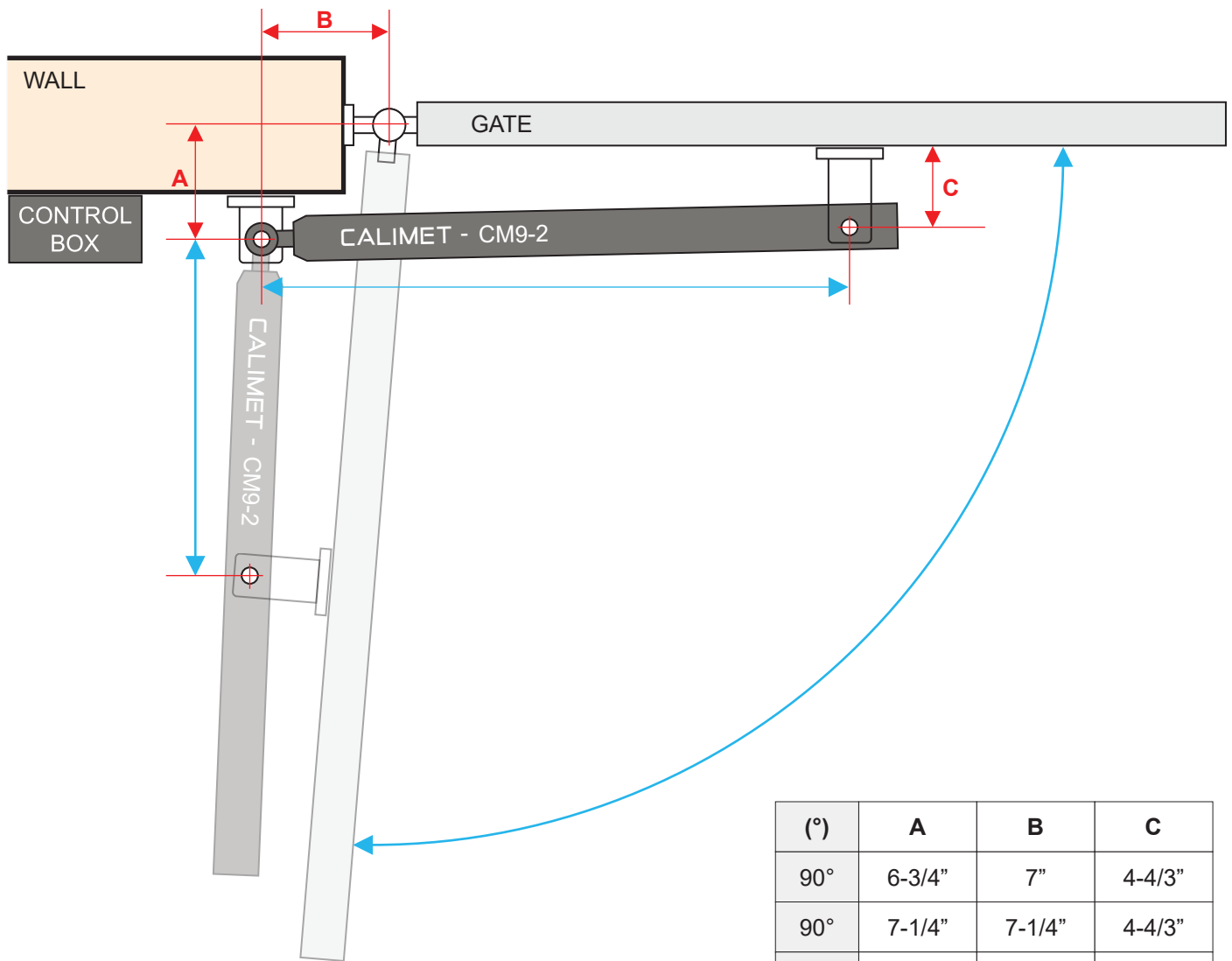

(°)	A	B	C
90°	6-3/4"	7"	4-4/3"
90°	7-1/4"	7-1/4"	4-4/3"
110°	6-3/4"	7"	4-4/3"
110°	5-1/2"	6"	4-4/3"

LINEAR ARM INSTALLATION (OPEN OUTSIDE)



OPEN OUTSIDE

Single Gate Installation Set-up



OPEN OUTSIDE

Double Gate Installation Set-up

1. Make a custom Fabrication L-Shape bracket to extend the length of your Linear Arm operator. The size is depend on your gate.
2. Weld the Wall Bracket to the Fabrication L-Shape bracket and then to the Wall Plate to create a stable base for the linear arm (FIGURE A).
3. Your finished Wall Plate should look like what show in FIGURE B.
4. Mounting the Wall Plate to the Wall: first drill holes in the desired location on the wall, and use wall anchors to securely mount the Wall Plate to the wall.
5. Use the included nut, washers, and bolt to connect the CM9-2 Linear Arm to the Wall Plate. Tighten the bolt to secure the Linear Arm to the Wall Plate (FIGURE C)
6. Position the Gate Plate to be level with the CM9-2 Linear Arm. Once everything is leveled and measured, weld the Gate Plate to the gate, and ensure that the plate covers up to 3 pickets on the gate (FIGURE D).
7. Connect the Gate Mount Bracket to the Linear Arm travel bolt. Adjust the bracket until the measurements match the suggestions on page 10.
6. Weld the Gate Bracket securely to the Gate Plate, and Verify that everything is stable and secure



FIGURE A



FIGURE B

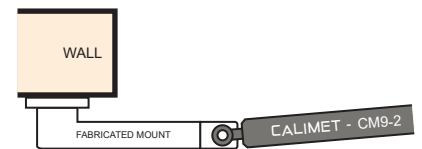
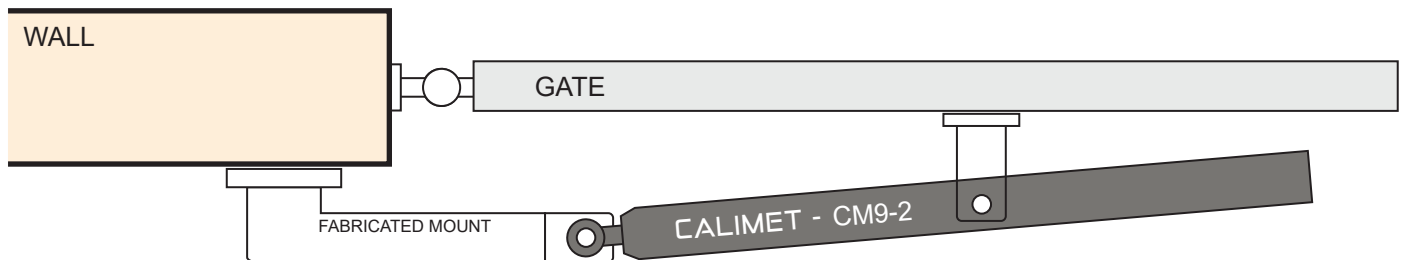

FIGURE C



FIGURE D



Please note that welding should be done by a professional and skilled welder to ensure safety and durability. Additionally, follow all safety guidelines and use appropriate tools and materials as specified in the product's manual or instructions.

LINEAR ARM INSTALLATION (OPEN OUTSIDE)

Refer to the illustrations below to determine the measurement of the swing linear arm operator.



OPEN OUTSIDE

Single Gate Installation Set-up



OPEN OUTSIDE

Double Gate Installation Set-up

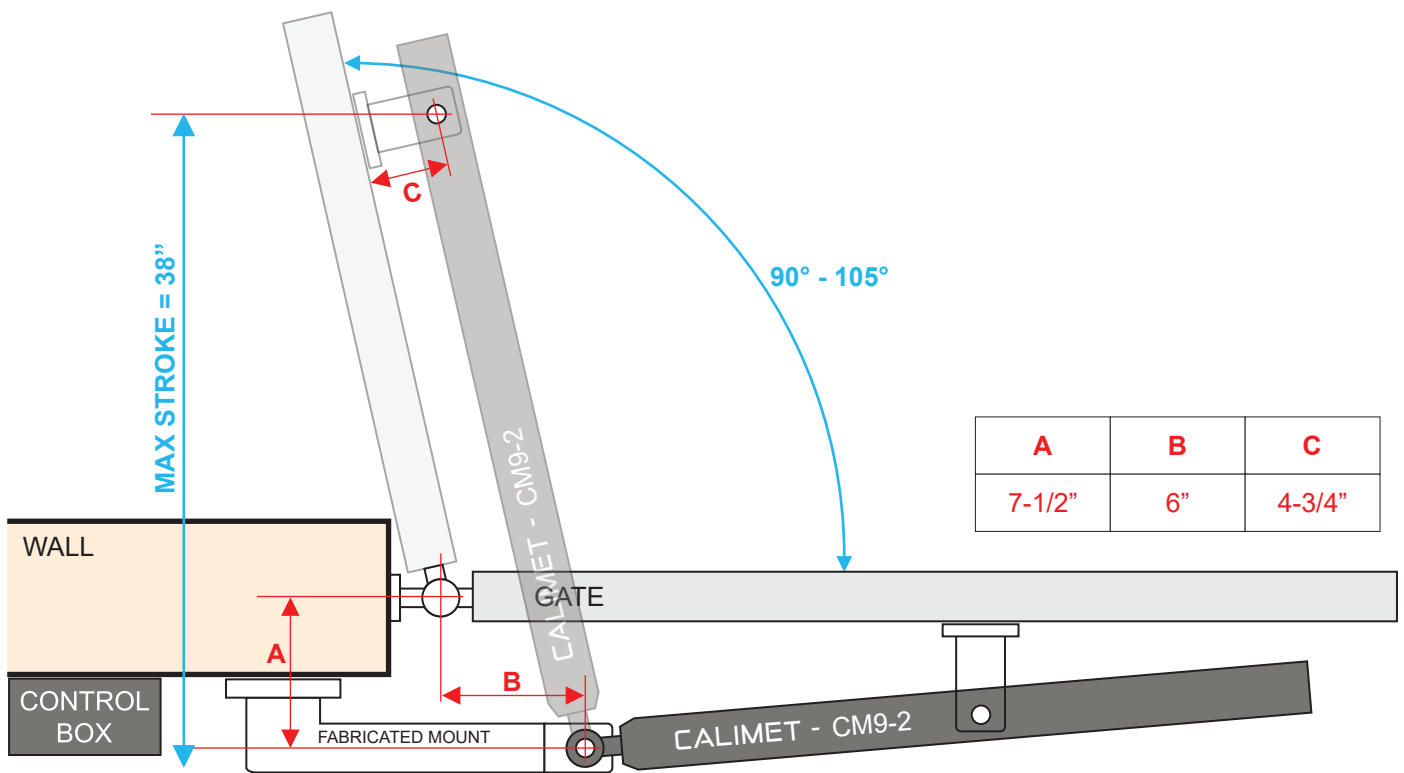

The Position of the brackets establishes the maximum opening angle and the length of the actuator's linear stroke. (NOTE: Rear bracket MUST be fabricated.)

ARM POSITIONING GUIDANCE

Please use the images below for your reference:

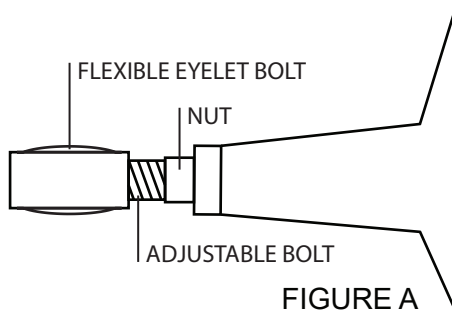
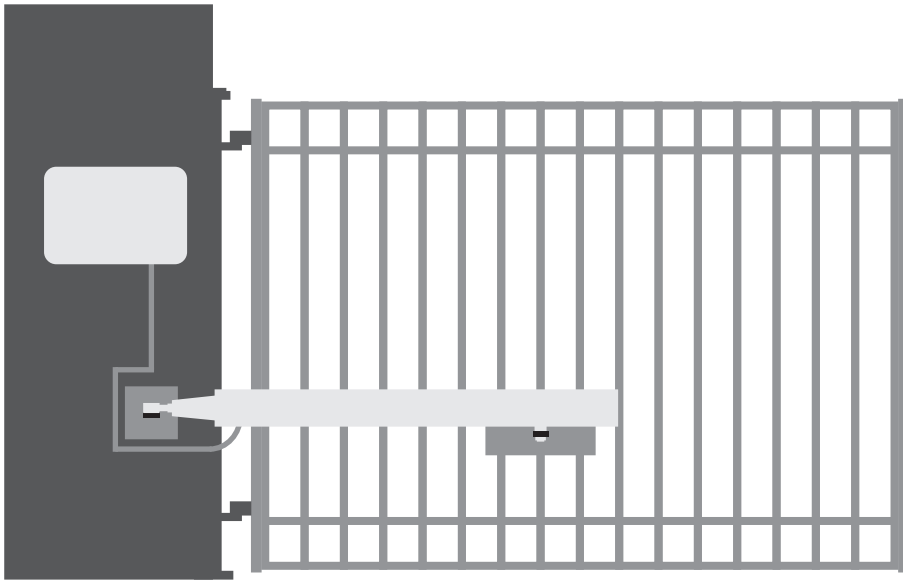

Flexible Eyelet Bolt Features:

Adjustable Length - Extend up-to half (1/2) inch. Must have at least half inch screwed in and connected with the linear arm and nut must be tight.

Flexible Angle - Allow up to 10° to 15° on move up or down and left or right.

CIRCUIT BOARD LAYOUT

Gate Operator Model: CM9-M9-2-DCNB, CM9-M9-2-DCFP, and CM9-M9-2-DCFP.S

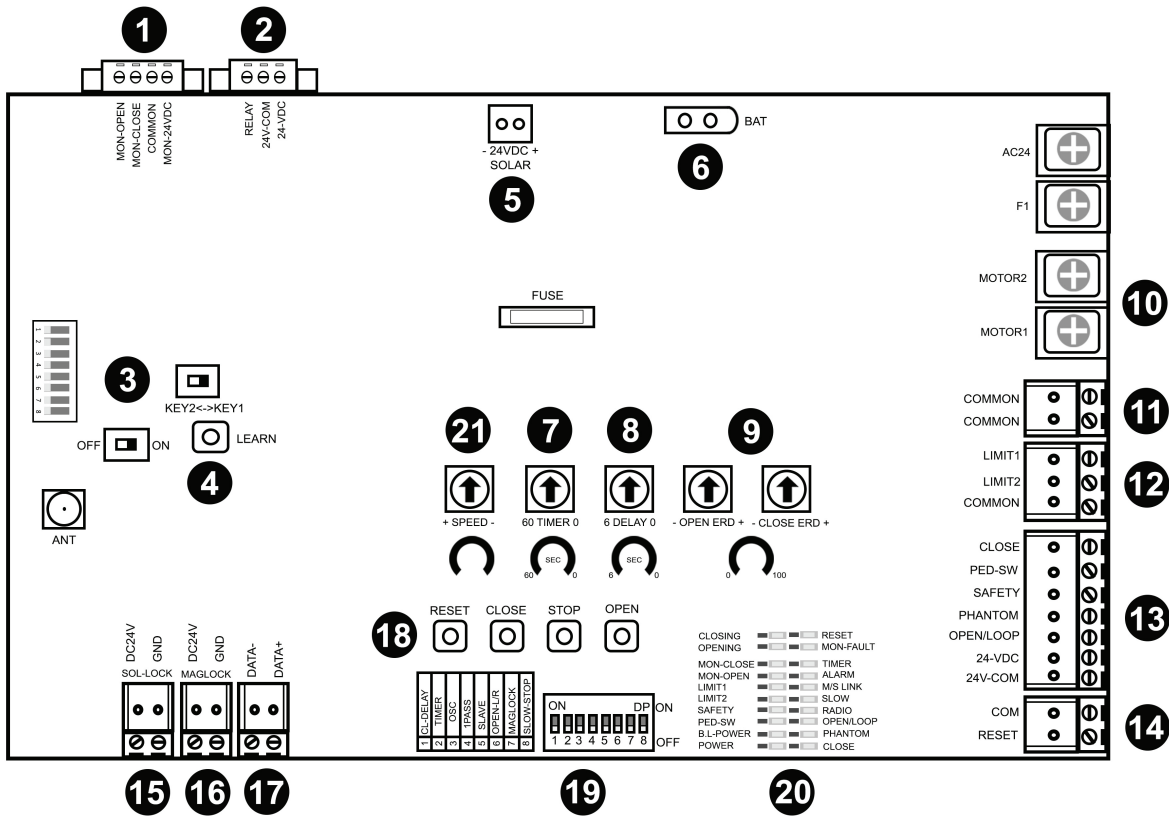

- 01 - Photocell Sensor Input
- 02 - Wired Keypad / Access Control Input
- 03 - Remote Control Dip Switch Setting
- 04 - Remote Control Learn (Study) Setup
- 05 - Solar Panel Wire Input
- 06 - Backup Battery Wire Input
- 07 - Auto Close Timer Knob
- 08 - Delay Timer Knob
- 09 - Open and Close ERD Knob
- 10 - Motor Input
- 11 - Common Input
- 12 - Open / Close Limit Input
- 13 - Loop Detector Input
- 14 - Common Global Input
- 15 - Electric / Solenoid Lock Input
- 16 - Maglock Input
- 17 - Master / Slave Dual Gate Input
- 18 - Open / Close / Stop / Reset Buttons
- 19 - Dip Switches Features
- 20 - LED Status Lights
- 21 - Speed Knob

DIP SWITCH FEATURES

Gate Operator Model: CM9-M9-2-DCNB, CM9-M9-2-DCFP, and CM9-M9-2-DCFP.S

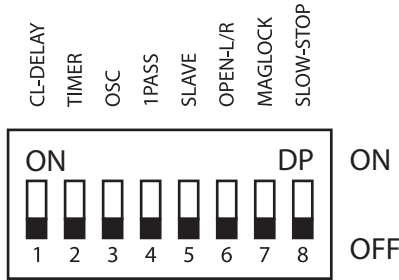

FIGURE A

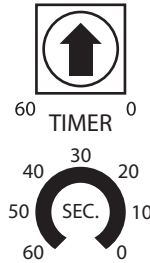

FIGURE B



FIGURE C

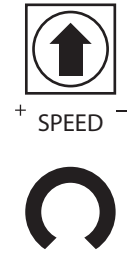

FIGURE D

Switch	Name	Description
1	CL-DELAY	Gate Closing Delay - switch to ON position, turn timer to 1 - 6 seconds (FIGURE C). Useful for dual gate operators with locks, requiring one gate to close first before the other, also known as “Bipart Delay”.
2	TIMER	Auto Close - automatically closes the gate after a timed delay. Set to ON and turn the blue TIMER knob anywhere from 1 - 60 seconds (FIGURE B).
3	OSC	Mid-Stop - allows the remote control to stop the gate when opening or closing. Press once to stop the gate, and press the remote again to reverse the gate. Automatic Close Override - pressing the remote control will override the close timer before the timer ends, allowing the gate to close early.
4	1PASS	Anti-Tailgating System - when On, after a vehicle has cleared the safety loop, the gate will start to close immediately. If a second vehicle crosses the loop while the gate is closing, the gate will stop. The second vehicle must get off the loop before the gate closes completely.
5	SLAVE	Dual Gate Installation - for the secondary gate operator only, set the #5 SLAVE switch to ON. If single gate installation, set to OFF.
6	OPEN L/R	Gate Open Direction - set the direction of which the gate opens when viewed from inside the property : Left or Right.
7	MAGLOCK	Maglock - turn on if using a magnetic lock. Wire the magnetic lock in the MAG-LOCK input on the bottom left of the circuit board.
8	SLOW-STOP	Slow Stop - Allows the gate to come to a slow stop when closing.

SPEED - The gate opening and closing speed can be adjusted by turning the blue knob labeled “SPEED” on your gate opener circuit board. turning left increases the speed and turning right decreases the speed.

CONTROL BOX WIRING

To ensure safe and proper installation, it is essential to follow these steps carefully and refer to the specific model's user manual or manufacturer's guidelines. Here's a summarized version of the steps for connecting the linear arm, photosensor, and power cable to the power box:

Step 1 - Connect the Linear Arm with the Power Box:

1. Unscrew the large water-resistant cable gland on the cable and insert into the pre-drilled hole located
1. on the bottom left of the power box. Hand-tighten until secure.
2. Follow the label on the wire and connect it to the circuit board as follows:
 - a. Motor Cable: Motor 1 (Red), Motor 2 (Black)
 - b. Physical Limit Cable: Common (Yellow), Common (Green), Limit 1 (Purple), Limit 2 (Grey)
 - c. Sound and Light Cable: MAGLOCK Port - DC24V (Orange), GND (Blue)

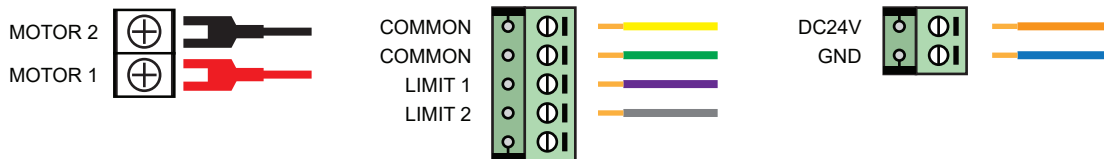

Step 2 - Connect the Photosensor with the Power Box:

1. Unscrew the large unused water-resistant cable gland (located on the bottom left of the power box).
2. Insert the Photosensor cable through the cable gland and hand-tighten it to secure.
3. Follow the label on the wire and connect it to the circuit board as follows:
 - a. Photosensor Cable: MON-CLOSE (Brown), COMMON (Blue/White), MON-24VDC (Grey)

NOTE: Some photocell sensors may have 3 or 4 wires

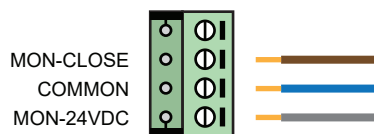

3 WIRES WIRING DIAGRAM

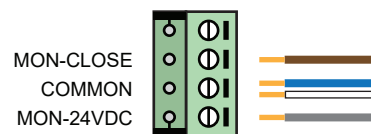

4 WIRES WIRING DIAGRAM

Before proceeding with the installation, make sure to read the entire installation manual provided by the manufacturer, including any safety guidelines and precautions. It's also recommended to have a qualified professional or technician handle the installation to ensure the gate opener system is correctly set up and safe to use.

POWER CONNECTION

1. Use UL approved electrical wires, stranded copper, connected to 110-120V AC electricity. Electrical wires **MUST** have a minimum capacity for 15 AMP current. See (FIGURE A) below for the correct electrical wire gauge size. Wires must be placed in a PVC or other underground conduit.
2. Turn off the AC power from the main power source circuit breaker.
3. Connect the green wire to the green wire (GROUND) wire using a wire nut (FIGURE B).
 - a. Alternative: connect the green wire to the earth ground rod and AC ground wire nut.
 Note: The earth ground rod can be grounded to the chassis.
4. Connect the white wire to the white wire (NAUTRAL) using a wire nut (FIGURE B).
5. Connect the black wire to the black wire (HOT LINE) using a wire nut (FIGURE B).



6. All operators **MUST** be properly grounded in order to prevent an electrical charge. Must use a dedicated circuit for power supply.
7. Turn ON AC power from the main power source and turn the power switch on the gate operator to the ON position. For DCFP (backup battery) and DCFP.S (solar and batteries) model gate operators, turn the battery switch to the ON position (FIGURE C).

Distance	Gauge
0 - 200 FT	14 AWG
201 - 400 FT	12 AWG
401 - 650 FT	10 AWG
651 - 1000 FT	08 AWG
1001 - 2000 FT	04 AWG

FIGURE A



FIGURE B

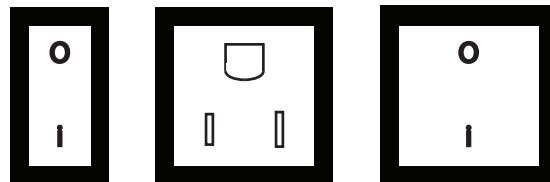

FIGURE C

GATE OPEN DIRECTION SETTINGS

Determine which direction your gate opens when viewed from the inside

Dip Switch Number 6 (FIGURE A) on the bottom of the gate operator circuit board controls the open direction.

ON = open to the right

OFF = opens to the left

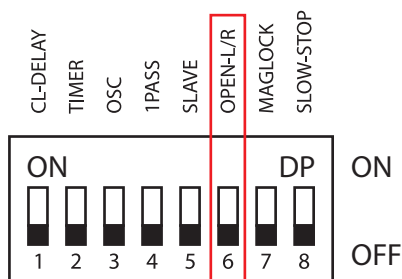
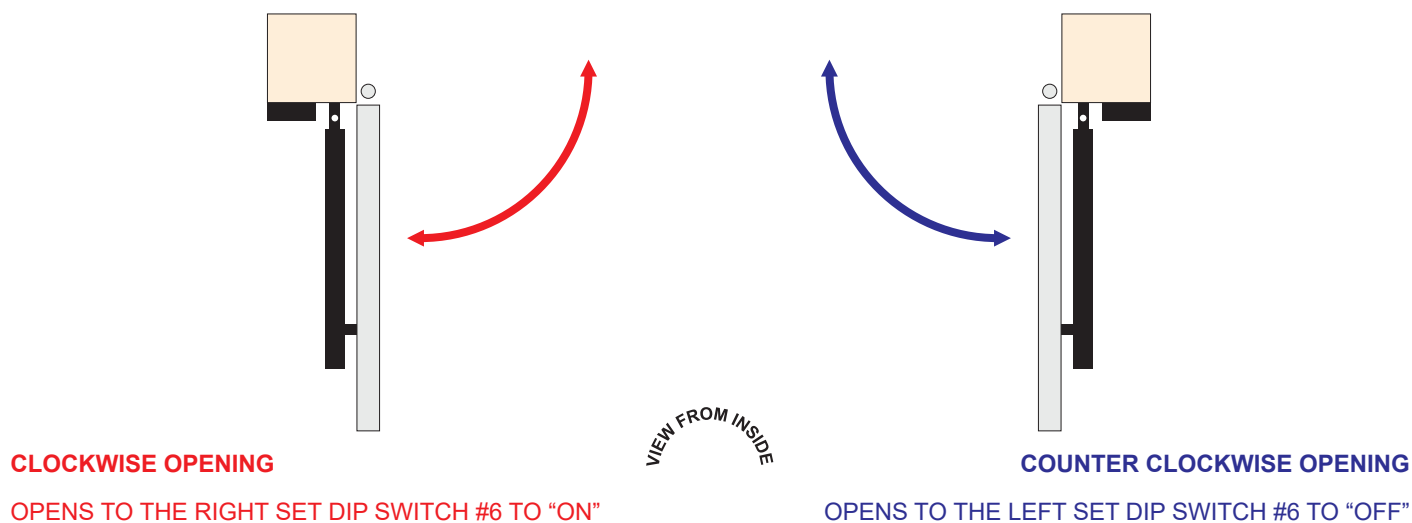

FIGURE A



DUAL GATE WIRING AND SETUP

This setup is for dual swing gate. A single button press of the remote control can open both gates. This requires two (2) gate operators. One gate operator is the “PRIMARY”, and the other is the “SECONDARY”.

All accessories including remote controls, photocell sensor, loop detectors, etc. must be installed/programmed on the “PRIMARY” gate operator only. Only one photocell sensor is required, and duo photocell sensor is optional.



1. On the “SECONDARY” gate operator circuit board, set dip switch number 5 to on (FIGURE A).
2. Press the reset button on the “SECONDARY” gate operator circuit board.
3. A 18 - 222 gauge, 2 conductor, stranded, copper, electrical wire is required.
4. Locate the DATA - and DATA + green terminal on the bottom left of the circuit board (FIGURE B). Use a flathead screwdriver to release the 2 locks on the top on the green terminal.

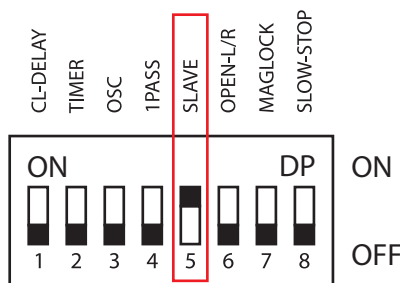

FIGURE A

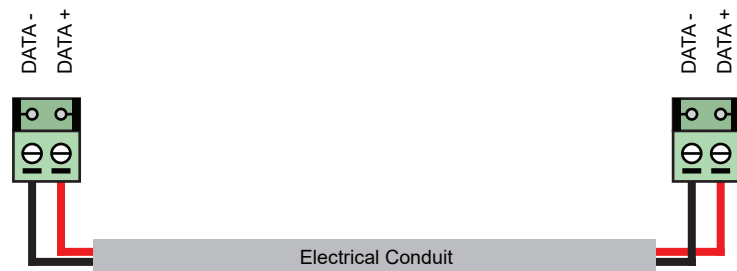
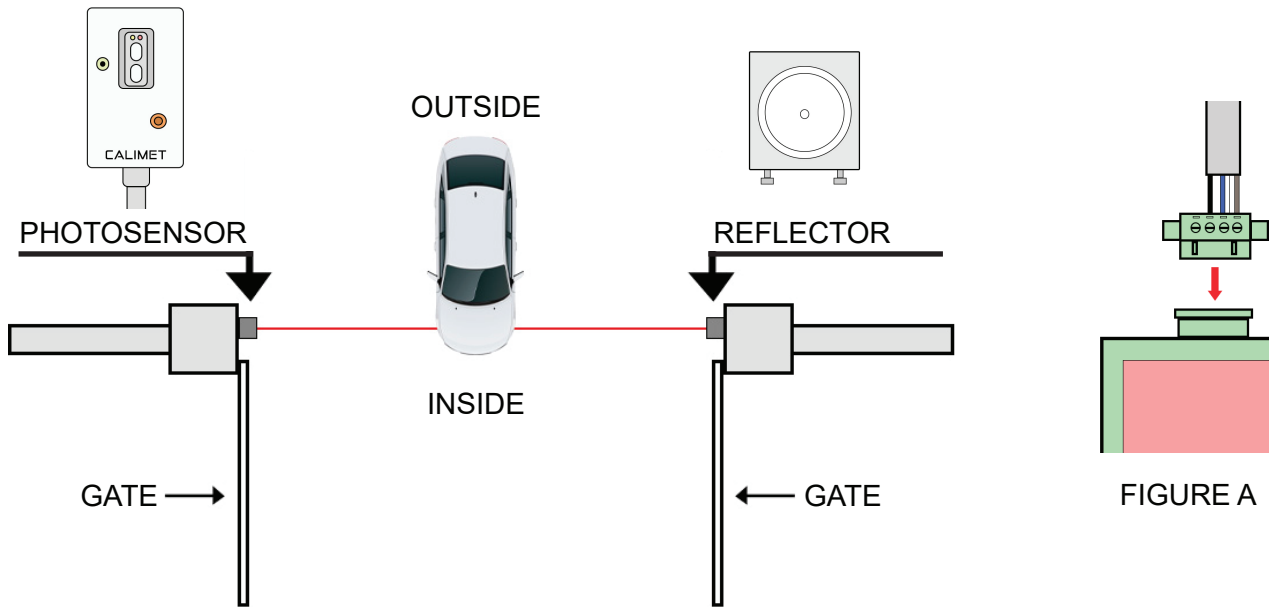

FIGURE B

5. Using the electrical wire, connect the DATA + on the primary gate opener, to the DATA + on the secondary gate opener. Connect the DATA - on the primary gate opener to the DATA - on the secondary gate opener. The M/S link LED light should now be lit on both circuit boards.
6. Use a flathead screwdriver to close the two locks on the top of the green terminal.
7. Place the cable underground in an electrical conduit. This conduit must be separate from the main 110 - 120V AC electricity conduit.

PHOTOCELL SENSOR INSTALLATION

The photocell sensor is a safety device that prevents the gate from hitting a vehicle or pedestrian when the gate is closing. The photocell sensor emits an invisible retroreflective infrared beam that detects when objects pass through.



1. Plug the photocell sensor cable to the back of the control box, behind the circuit board with a green input with the label: "MON-OPEN", "MON-CLOSE", "COMMON", "MON-24DC". (Figure A)
2. Press the reset button on the control box circuit board.
3. Use the two included mounting brackets to mount the photocell sensor on a post or wall OUTSIDE your gate, 21" from the ground.
4. Press the orange button on the photocell sensor to turn on the alignment laser.
5. Mount the reflector to the opposite side. Make sure it is level with the photocell sensor (Figure C) and the alignment laser beam hits inside the circle of the reflector. (Figure B)
6. Press the orange button on the photocell sensor to turn off the alignment laser.
IMPORTANT!!! Alignment laser must be off (Figure D)

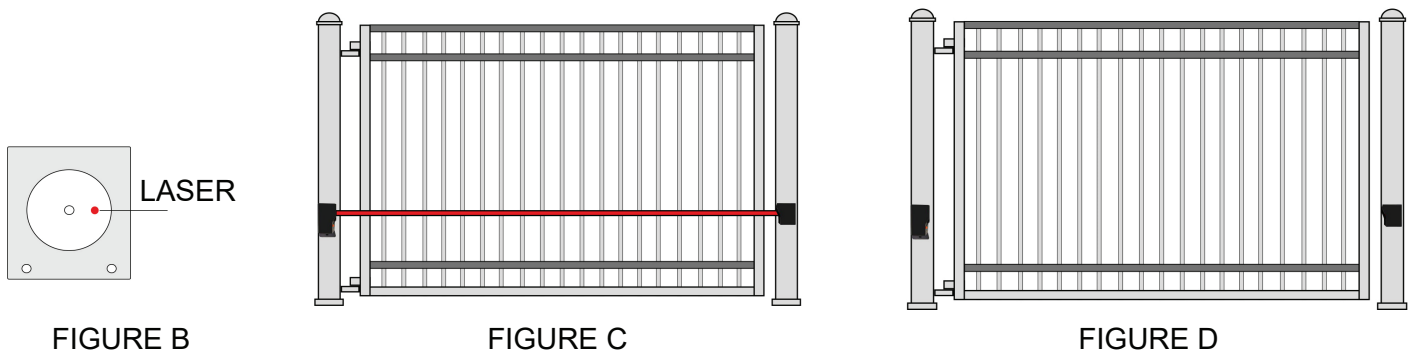

PHOTOCELL SENSOR LED INDICATORS

Use the light signal below as a reference when trouble shooting.

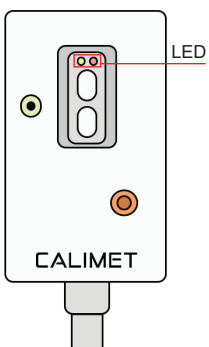

LED INDICATORS	
Yellow and Red ON	Relay is energized and signal is aligned and stable.
Yellow OFF, Red ON	Relay is energized, reflector is on the edge of the signal path
Yellow and Red OFF	beam is obstructed or sensor is not aligned with the reflector

NOTES

1. The default photocell sensor range is 30'. For a longer range, please upgrade to the CM9-487, which has a max range of 50'.
2. The photocell sensor cannot be used for a detection area less than 0.5'.
3. If you need to place the photocell sensor further away, extend the photocell sensor wires by joining (splicing) with another 20 - 22 AWG wire.

SECONDARY PHOTOCELL SENSOR (OPTIONAL)

A second photocell sensor can be installed inside the gate to monitor the OPEN cycle.

This secondary photocell sensor goes inside your property, past the gate's fully open position. If the photocell sensor's cable isn't long enough you will need to extend (splice) the wires by joining them with another 20 - 22 AWG wire for the secondary photocell sensor to be able to reach the gate operator input.

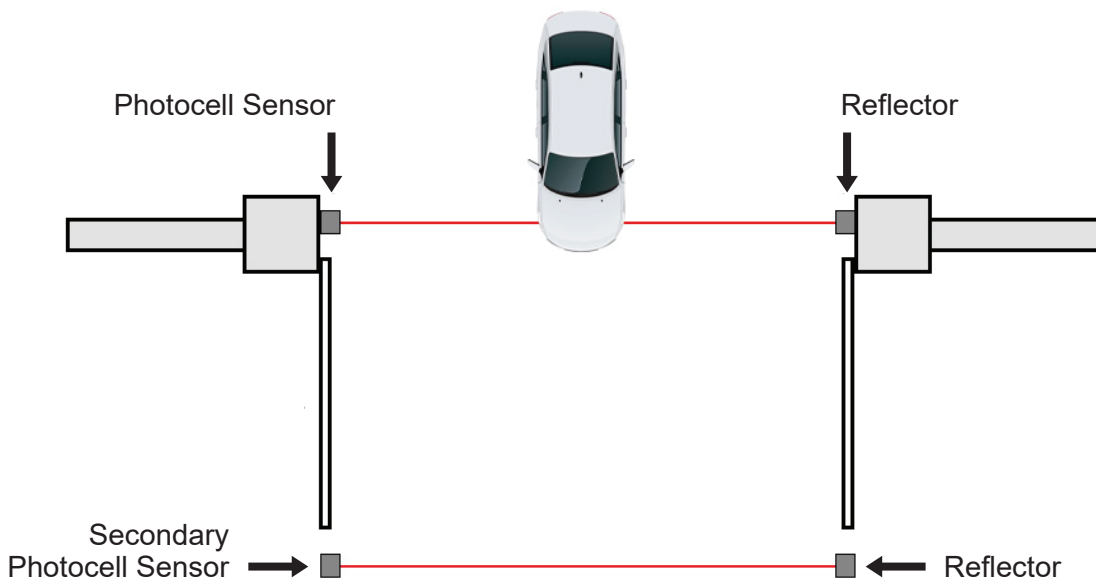

Secondary Photocell Sensor Wiring

Use the same green terminal block input as your primary photocell sensor. Each input can have more than 1 wire inserted. Different model photocell sensors contain 3 or 4 wires.

3 Wires: MON-OPEN (Brown), COMMON (Blue), MON-24VDC (Grey)

4 Wires: MON-OPEN (Brown), COMMON (Blue/White), MON-24VDC (Grey)

Depending on how many your photocell sensor contains, follow the wiring diagram below:

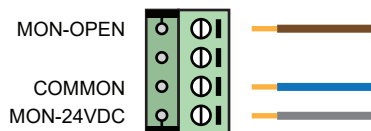

3 WIRES WIRING DIAGRAM

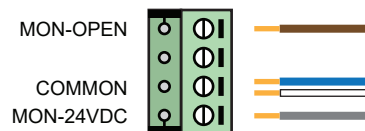

4 WIRES WIRING DIAGRAM

PHYSICAL LIMITS ADJUSTMENTS

1. Unscrew the top 2 Philips screws that are holding the front cover in place. Carefully store these screws in a safe place since this part is not replaceable and may be needed later for reassembly. (FIGURE A)
2. Slide open the top cover panel to gain access to the limit adjust bar. This will expose the mechanism that controls the limits of movement for the Linear Arm.
3. Locate and loosen the two screws that hold each limit bar in place. By loosening these screws, you can move the limit bar to the desired position for adjusting the limits of movement.
4. Adjust the limit bar to the desired position based on your requirements. Once you have set the limits as needed, tighten the screws securely to hold the limit bar in place.
5. After completing the limit adjustment, slide back the top cover into its original position, ensuring that all components are properly aligned.
6. Reinstall the front cover by carefully placing it back into position and securing it with the two Philips screws you removed in the first step.

If you are unsure about the adjustment process or encounter any difficulties, it is recommended to seek assistance from a qualified technician or the manufacturer's support team.

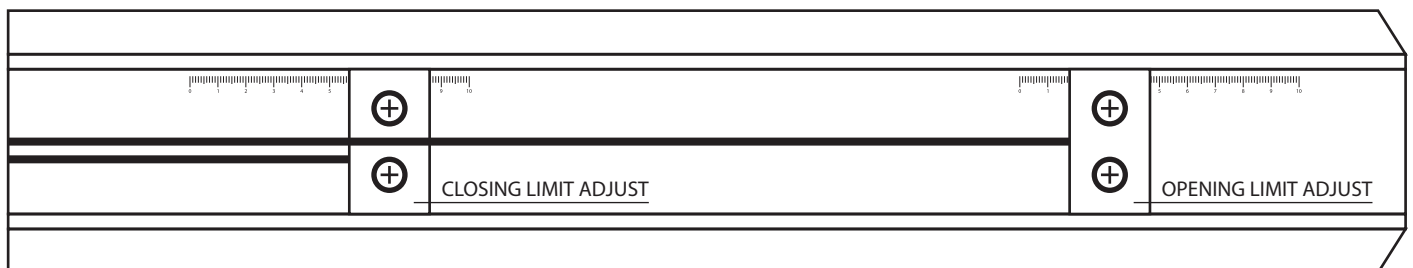

FORCE ADJUSTMENT

The Electronic Reversing Device (ERD) is a feature on the circuit board which detects when the gate comes in contact with an obstruction, causing the gate to reverse. These are the 2 blue knobs on the circuit board. The open and close knobs determine the amount of force required to reverse the gate (FIGURE A). We generally recommend leaving the knob at 50. you may adjust the positions based on your particular gate. If the gate reverses without touching an obstruction, the ERD is set too low. if the gate does not reverse when it hits an obstruction, the ERD is set too high.

NOTICE - Test ERD every 6 months.

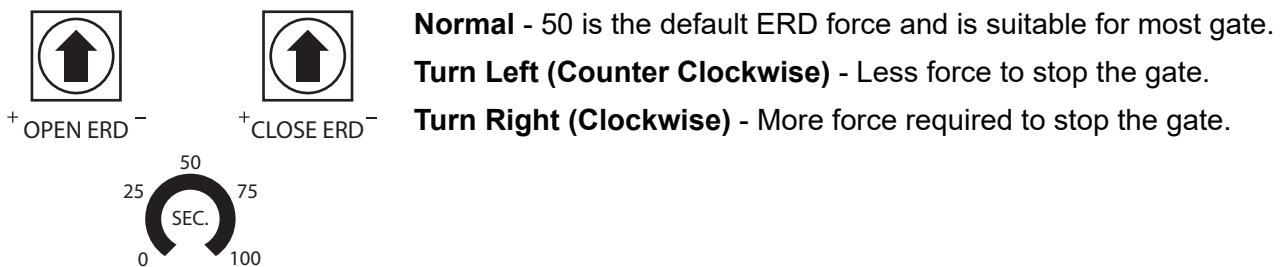

FIGURE A

Obstruction Test

1. Place a light object (ex. chair or trash can) between the open gate and the post.
2. Close the gate. the gate should stop and reverse when it touches the object. if the gate does not reverse when it touches the object, press the STOP button on the circuit board. Reduce the ERD force by turning the CLOSE ERD knob counter clockwise.
3. Do the same test again for the open direction.
4. Test the gate operator after any adjustments are made.

WARNING

1. Never increase force beyond the minimum amount required to move the gate. Too much force may seriously injure or kill.
2. Never use force adjustments to compensate for a improperly installed, improperly maintained, or a damaged gate. The gate must normally move freely with no obstructions.
3. The ERD must be tested after making any changes. The gate must reverse when it comes in contact with an object.

WARNING SIGNS INSTALLATION

Warning signs are to alert people that a possible hazard exists with moving gates, so that appropriate action can be taken to avoid injury.

Install the 2 supplied warning signs in locations where the signs are visible by people on both sides of the gate. they may be installed directly on the gate. or a nearby wall or post.

use screws (not supplied) to install the warning signs.



FINISHED! You are now finished installing your gate operator.
see the next page for post-installation instructions.

EMERGENCY RELEASE LOCK

The emergency release lock allow you to open and close the gate manually, such as in cases during a power outage and there is no electricity.

1. Unlock the Emergency Release Lock with the key
2. Push the gate open using your hands
3. When finished, lock the Emergency Release Lock
4. Store the key in the safe area with label for easy access

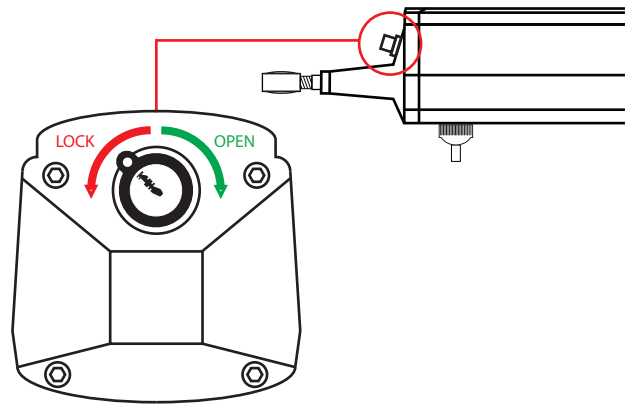

AFTER INSTALLATION

Accessories - Additional accessories such as keypads, exit loops, and access controllers can be purchased and installed to your gate operator. Ask your dealer or distributor for more information or visit our website <https://calimetco.com> and click on ACCESSORIES tab to view all available accessories.

Warranty - Register your warranty using the warranty card included in the box. This will require the serial number of the gate operator which is located underneath the black cover, outside the circuit board compartment. After you are done, mail in your warranty to the address specific on the card. Additionally, you may register your warranty online by visiting <https://calimetco.com/warranty>.

***NOTICE IF YOU FAIL TO REGISTER WITHIN 30 DAYS OF INSTALLED DATE. YOUR WARRANTY WILL ONLY VALID FOR 1 YEAR WARRANTY.**

Auto-Close Timer - Most homeowners prefer the gate to close automatically after they drive through it. See the “Dip Switch Features” Page, specifically the number 2 “TIMER” section to set up the auto-close timer on your gate operator.

Dual-Gate Installation - For double gates, visit the “Dual Gate Setup” page for more installation instructions.

Homelink / Car Setup - Most modern cars come with a feature called Homelink that lets you open your gate by pressing a button on your car. Calimet gate operators are compatible with Homelink. Visit the link: homelink.com/program/vehicle and enter your car model to view specific instructions. For order cars, or cars with software that isn't Homelink, check your car's manual for setup instructions.

Safety - Read this instruction manual to learn the common features of a gate operator and their functions. Learn how to turn off the power and how to use the emergency key/lock release in cases of a power outage. Keep your gate maintained by following the “MAINTENANCE” page instructions. Read the “SAFETY” page to learn the dangers of a moving gate. Educate all individuals on the property of the dangers of a moving gate. Keep all children away from moving gates. DO NOT allow children to play on or near the gate or operate the remote control.

Installers - Fill out the “NOTES” page with the gate operator model and serial number and provide them with your contact information. Leave instruction manual and product literature with the owner or end user.

REMOTE CONTROLS

By default, the included remote controls are already connected to the gate operator. You do not need to do any of the following steps unless you are adding more remote controls to your system.

This gate operator can add up to 50 different remote control. to add more than 50 controls, you need to add an addition reciever, which can add up to 100 additional remote controls. Calimet remote controls use 418 MHz frequency with a 300' max distance. there are two ways to connect: Learn and Dip Switch.

Program by Learn (CM9-864, CM9-510, CM9-510B)

Connect Using Learn - On your gate operator circuit board, look for the learn button. Press and hold the LEARN/STUDY button until the flashing light turn solid, about 2 sec. Then release and immediately press and hold the button on the remote control. Release until LEARN/STUDY light flashing again. Your remote is now connected with your gate operator.

Remove All Existing Remote Control - Press the LEARN/STUDY button on the gate operator circuit board and hold for 8 seconds (The light pattern is flashing - solid - flashing) then release. All remote controls are now removed.

Program by Dip Switch (CM9-509)

1. On your circuit board find the 1-8 Dip Switch, turn the nearby OFF/ON switch to ON.
2. Unscrew the back of the remote control to gain access to the control circuit board. your should see 1-8 dip switches. each switch has 3 positions: UP, MIDDLE, and BOTTOM. Flip these 1-8 switches to any random position to created your own code (FIGURE A).



FIGURE A

3. On the gate opener circuit board, set the same 1-8 dip switch combination as you did on the remote. your remote is not connected to the gate opener.

NOTICE - Do not share your dip switch code and keep it safe. Anyone have access to your code will have access to your gate system.

VEHICLE LOOP DETECTORS

An exit loop is a device that opens the gate automatically when a car approaches the gate.

A reverse loop is a loop that reverses the direction of a closing gate if a car drives over it. It will also hold the gate open if a vehicle stops over the loop. If the gate is fully closed and a vehicle drives over it, the gate will not open.

A phantom loop is a reverse loop located inside the property.

NOTICE - WE DO NOT RECOMEND USING TIMER (AUTO-CLOSE) FEATURE UNLESS YOU HAVE VEHICLE LOOP DETECTORS AND WIRELESS EDGE SENSOR INSTALLED. CALIMET IS NOT LIABLE TO ANY DAMAGES CAUSE BY USING TIMER (AUTO-CLOSE) FEATURE WITHOUT A VEHICLE LOOP DETECTORS AND WIRELESS EDGE SENSOR.

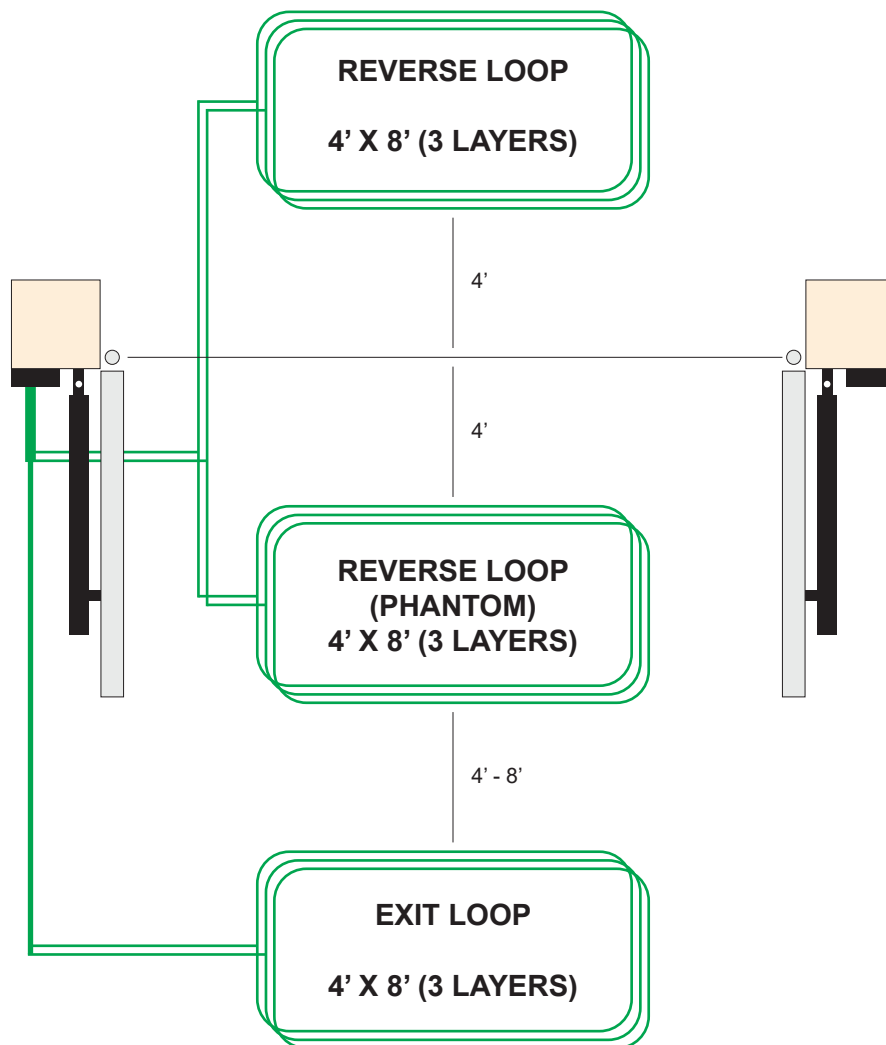

VEHICLE LOOP DETECTORS - WIRES INSTALLATION

Loop wires are installed 1.5" underground by cutting the concrete drive-way with a circular saw. The typical size loop is 8' x 4'. Common loop wires are size 16 or 18 AWG stranded copper XLPE. (cross-linked polyethylene) electrical wire. 3 layers of turns are required for a typical 4' x 8' loop. For different size loops, use 4 turns for 10 ft to 20 ft in perimeter, 3 turns for 20 ft to 32 ft in perimeter, and 2 turns for 32 ft - 98 ft in perimeter. The wire ends must be placed inside a PVC conduit. Use caulk or sealant to close the ground once finished.

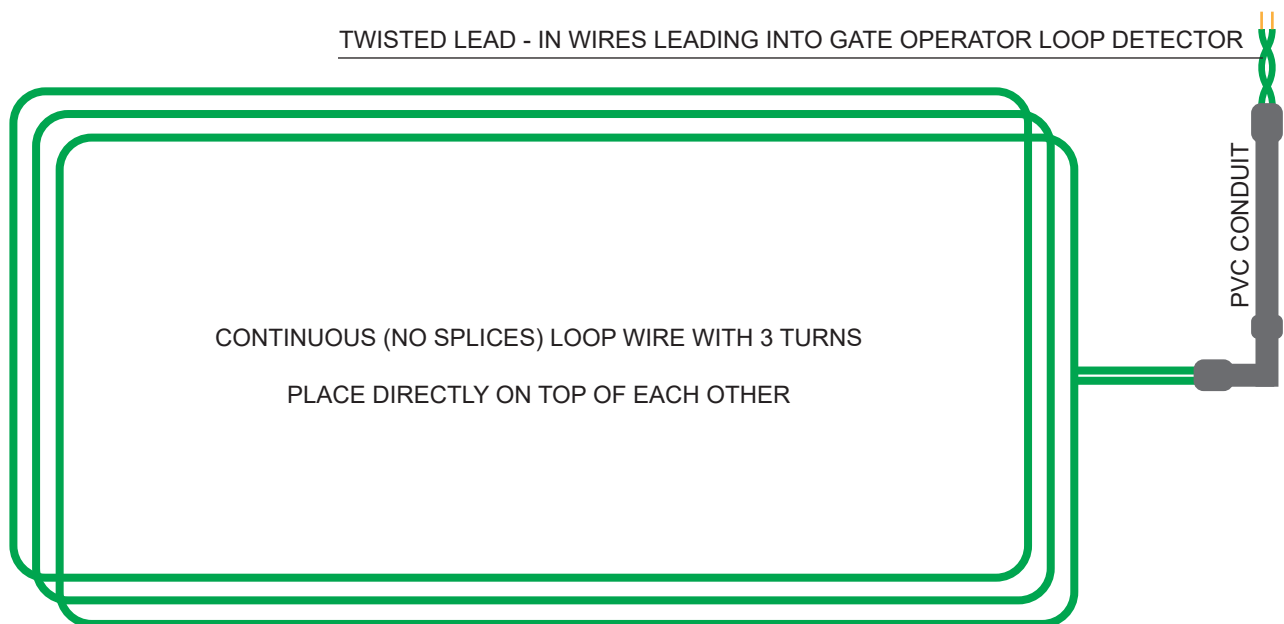
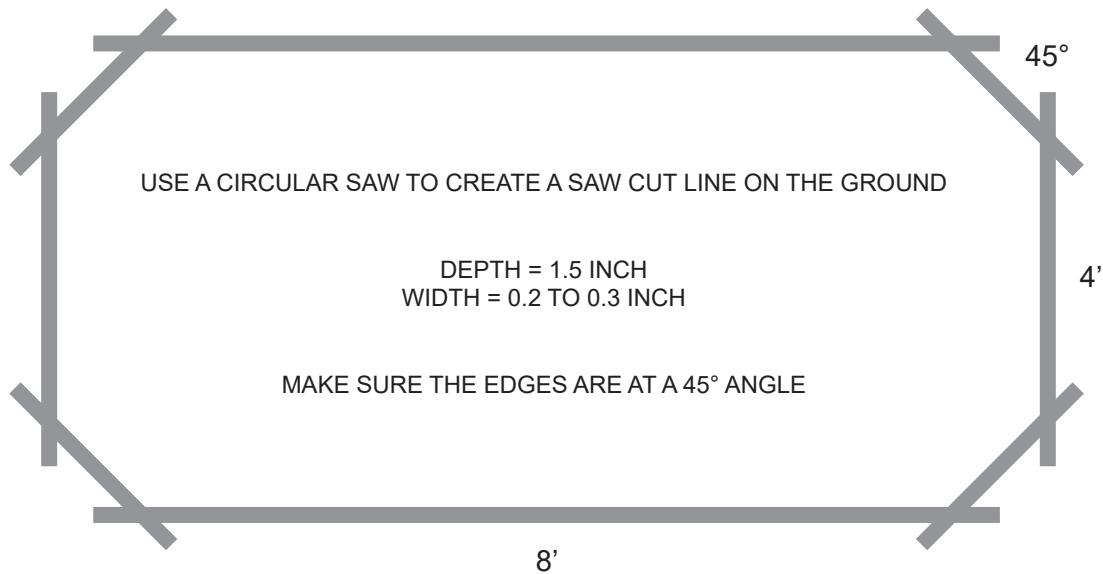

VEHICLE LOOP DETECTORS - WIRES INSTALLATION

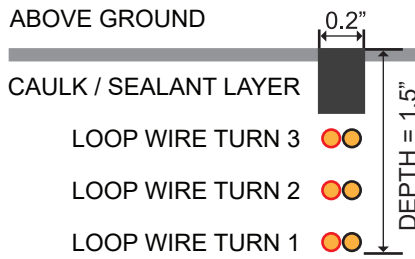

Loop Size (SQFT)	Number of Turns
6FT to 12FT	6
13FT to 20FT	5
21FT to 60FT	4
61FT to 240FT	3
241FT +	2

If you purchased a Calimet Loop Detector Harness, see the wiring diagram below to connect the loop detector to the gate operator circuit board. For other brand vehical loop detectors or exit wands, use the OPEN/LOOP input, and 24-VDC and 24V-COM if using the gate operator to power the device.

For reverse loops located on the inside of gate, use the PHANTOM input. For reverse loops located on the outside of the gate, use the SAFETY input

The exit loop inputs are located on the bottom right of the gate operator circuit board.

Vehicle Loop Detector Harness to Gate Operator Wiring Diagram

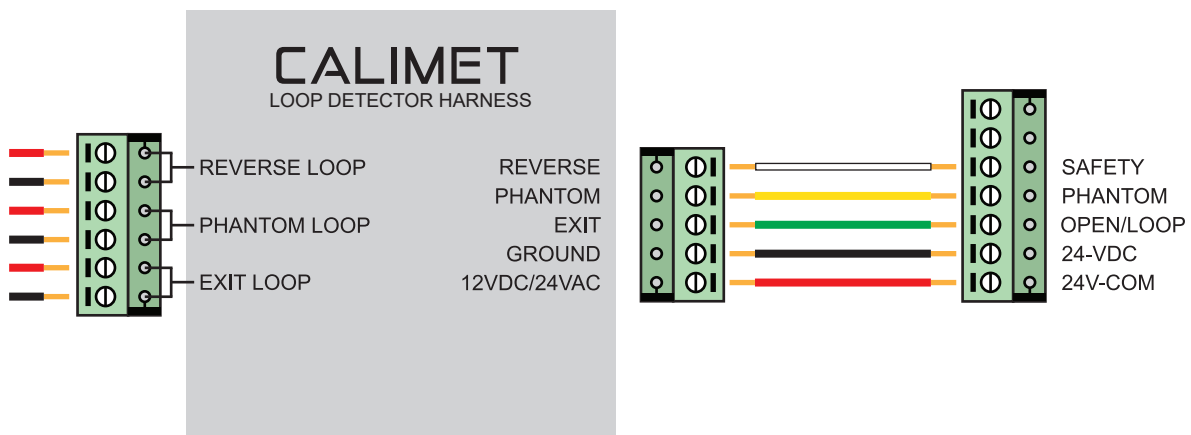

Loop lead-in wires connect directly to the loop detector harness, and not the gate operator circuit board.

ACCESSORY WIRING

Most accessories can be wired into the relay input.

Use OPEN/LOOP for Normal Open (N/O). Use Relay for Relay.

Use the CLOSE Input for Normal Close (N/C).

If Using the gate operator to power the accessory, use 24_VDC and the 24V-COM input

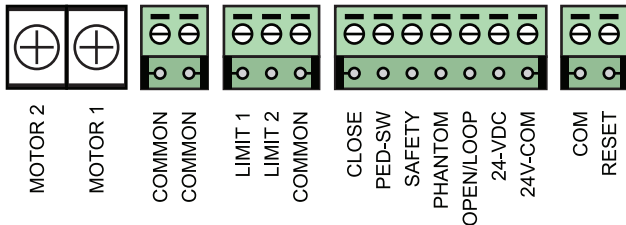

FIGURE A - **Exit Loop Terminals**

Located on the right side of the board

Commonly Used For:

1. Reverse/Phantom/Exit Loops
2. Electric Locks
3. Fire Access Box

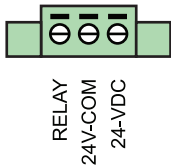

FIGURE B **Relay Terminals**

Located on the top right side of the circuit board mounting panel

Commonly Used For:

1. Intercoms / Access Controllers
2. Keypads

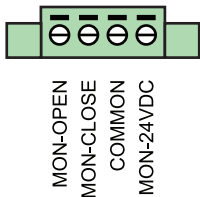

FIGURE C - **Monitored Terminals**

Located on the top right side of the circuit board mounting panel

Commonly Used For:

1. Photocell Sensors
2. Safety Edges

Solenoid / Electric Lock

Ver.3.1 Circuit Board: Use the SOL-LOCK input.

Ver.3.0 Circuit Board and below: Use the MOTOR1 and MOTOR2 terminal.

MagLock

Ver.4.2 Circuit Board: Use the MAGLOCK input and turn dip switch #7 (Labeled "MAGLOCK") to ON

Push To Exit Button

Normal Open (N/O) - OPEN/LOOP

Normal Close (N/C) - CLOSE

If using the gate operator to power the accessory, use 24-VDC and the 24-COM input

ACCESSORY WIRING

Receiver

Relay/Normal Open - Relay

Common - 24V-COM

12-24V DC - 24-VDC

Photocell Sensor (Non-Calimet Brand)

Monitored Close - MON-CLOSE

Monitored Open - MON-OPEN

Common - 24V-COM

12-24VDC - 24-VDC

Fire Access Box

Use 14-20 gauge awg wire (not included) and splice (join) with the white and black wires.

Common (White) - 24V-COM

N/O (Black) - OPEN/LOOP

Safety Edge Sensor

Calimet Brand - (CM9-934) is wireless and requires no wiring.

Other Brand - Use the MON-CLOSE or MON-OPEN input depending on if it's monitoring the open or close cycle. Use COMMON and MON-24VDC if the safety edge requires electricity.

Keypad

Calimet Brand - CM9-535 is wireless and requires no wiring but it's optional.

Other Brand - Use a 20 gauge stranded electrical wire and connect using the following:

Normal Open/Relay - RELAY

Common - 24V-COM

12-24VDC - 24-VDC

Access Controllers/Intercoms

Use a 20 gauge stranded electrical wire and connect using the following.

Normal Open/Relay - RELAY

Common - 24V-COM

12-24VDC - 24-VDC

If it requires a dedicated normal Open/Normal Close input, use the OPEN/LOOP input. The CLOSE input for Normal Close. The 24-VDC and 24V-COM can supply electricity to the intercom/access controller.

ACCESSORY WIRING

Backup Battery

24V batteries are added to the battery compartment at the bottom of the gate operator. There is a separate battery circuit board that connects to the BAT input on the main gate operator circuit board.

Batteries degrade over time depending on usage. Battery performance may decrease in extremely cold temperatures - performance can be increased by adding insulation to the inside of the gate operator battery compartment or adding a heater. The batteries should be replaced every 3-4 years.

Solar Panel

Solar Panels can be wired into the 24VDC SOLAR input on the gate operator circuit board.

Multiple solar panels may be wired together to charge the battery faster. we recommend two 24VDC solar panels for optimal charging.

Place solar panel at a 45 degree angle, facing SOUTH.

Note: optimal angle and orientation may vary based on our location and season.

Make sure the solar panel can receive direct sunlight. If a tree, or other forms of shade blocks the solar panel, move the solar panel to a different location.

CIRCUIT BOARD LIGHT STATUS CHART

NAME	STATUS / LIGHT
CLOSE	ON when CLOSE input is activated
PED-SW	ON when STAND BY, OFF when the STOP input is activated or key emergency is opened
SAFETY	ON when Stand By, OFF when SAFETY LOOP input is activated
PHANTOM	ON when incoming signal is detected from a reverse loop (PHANTOM)
OPEN/LOOP	ON when EXIT LOOP input is activated
LIMIT 1	ON when limit nut has reached the limit 1 switch
LIMIT 2	ON when limit nut has reached the limit 2 switch
RADIO	ON when the RADIO input is activated
RESET	ON when circuit board has been RESET
POWER	ON when the gate operator is on standby, blinks when motor is on
B.L-POWER	ON when back up battery is fully charged, blinks when low battery
M/S LINK	Blinks when master/slave communication is active
TIMER	Blinks when TIMER is counting down to close gate automatically
OPENING	ON when gate is in the open cycle
CLOSING	ON when gate is in the close cycle
MON-FAULT	ON when photocell sensor is malfunctioned or not leveled
MON-OPEN	ON when photocell sensor is monitoring the open cycle
MON-CLOSE	ON when photocell sensor is monitoring the close cycle
SLOW	ON when the SLOW-STOP dip switch features (#8) is turn on

Alarm

The alarm will sound in these following situations:

1. Photocell Sensor Obstruction / Misalignment - an object has crossed the photocell infrared beam when the gate was closing. If nothing interrupted the beam, the photocell sensor may be misaligned. Align photocell sensor with the reflector on the other side to fix the problem.
2. Impact Detection - The gate operator has a built-in impact sensor called the ERD. If the gate collided w/ an object, the alarm will sound. If there was no collision, the ERD force may be set too low. increase the force to fix the issue. Another possible issue is that the chain may be bent or not correctly aligned to the sprocket.
3. Low Battery - Battery is low. Recharge using solar panel or AC electricity. DCFP models only.

TROUBLESHOOTING

Problem	Possible Cause	Solution
Gate operator has no power	<ul style="list-style-type: none"> A. Electrical outage B. Circuit board tripped C. If using solar panel only, battery level may be depleted D. If using solar panel only, battery may need to be replaced E. Conduit and/or power cables are damaged or have corrosion F. Fuse blown due to electrical overload or faulty wiring G. Circuit board malfunction 	<ul style="list-style-type: none"> A. Wait until the power comes back on B. Reset Circuit Breaker C. Recharge the battery by using solar or AC electricity D. Replace battery E. Replace wiring F. Replace Fuse G. Replace circuit board
Gate operator does not open	<ul style="list-style-type: none"> A. No power B. Remote control has no battery C. Gate is damaged, misaligned or obstructed D. Emergency release key is open E. Circuit board malfunction 	<ul style="list-style-type: none"> A. Check to make sure electricity is working. If using solar only, give the gate operator 2-3 days to recharge the battery. B. Reset Circuit Breaker C. Check for any damages obstruction, or misalignment on the gate D. Step on the foot pedal and move it to the upper-left E. Replace circuit board
Gate operator can open but does not close	<ul style="list-style-type: none"> A. Photocell sensor is not aligned B. Open direction is reversed 	<ul style="list-style-type: none"> A. Align photocell sensor with the reflector on the other side B. Dip switch #6 OPEN-L/R - set to the opposite position
Gate does not close all the way	<ul style="list-style-type: none"> A. Limit positions not adjusted properly 	<ul style="list-style-type: none"> A. Re-adjust limit wheel position
Gate operator opens on its own	<ul style="list-style-type: none"> A. Radio frequency interference from another nearby gate operator B. Loop detector may be too sensitive to environmental vibrations 	<ul style="list-style-type: none"> A. Erase all remote controls on the system, and re-add each remote. B. Downgrade sensitivity on the loop detector
Gate reverses when traveling	<ul style="list-style-type: none"> A. Not enough force B. Low on Battery 	<ul style="list-style-type: none"> A. Increase OPEN ERD and CLOSE ERD blue knob B. Re-charge battery using solar or 100V AC electricity

MAINTENANCE

DESCRIPTION	TASK	MAINTAINING
Gate	Inspect swivel arm, hinges, posts, and other parts for wear, damage or mis-alignment. Lubricate if necessary. There should be no squeaking.	Every Month
Photocell Sensor Check	Place your hand over the photocell sensor infrared beam when the gate is closing. The gate must stop and reverse, if not contact installer or support.	Every Month
Safety Edge	Gate should stop moving when press the safety edges. If it doesn't, check the battery (3V CR2450) and replace if need. Battery life: 2-3 years.	Every Month
Emergency Release	Use the key and activate the emergency Release. Manually push the gate to ensure it can fully open and close. If not contact installer or support.	Every Month
Free Movement Check	Use the key and activate the emergency Release. Manually push the gate by hand to ensure it move freely and easily with little to no resistance.	Every Month
Warning Signs	Warning signs should be installed and visible by people inside/outside of the gate. Replace warning signs if damaged or wear and tear.	Every 3 Months
Force Check	Gate should reverse when it comes in contact with object. Test both open and close ERD force.	Every 6 Months
Accessories	Check all accessories including remotes, loop detectors, keypad, etc. to make sure they are all operating properly.	Every Year
Electrical Wiring and Connection	Check all electrical wiring connections to make sure none are loose or damaged. Use LICENSED ELECTRICIAN for any repair or replace.	Every Year
Chassis Sleeve Anchors	Check each anchors to make sure the anchors are not loose or damaged. Replace if need.	Every Year
Backup Battery	Replace new battery	Every 4 Years

MANUFACTURER'S LIMITED WARRANTY

The warrantor, CALIMET CO., INC, warrants the gate operator(s) for a period of three (3) years in commercial installations and for a period of five (5) years in residential installation to be free from defects in mortar, gearbox, circuitry, and workmanship. This warranty is limited to two (2) of any combination of repairs or replacement of parts. This warranty applies from the date of purchase to the original owner. Warrantor will repair or replace (at warrantor's sole discretion) any part which it finds to require service, excepting that, this limited warranty does not cover the following corrosion and, damage or failures resulting from environmental conditions, vandalism, water, lack of proper maintaince, accident, theft, fire, normal wear and tear, misuse, alteration, tampering, improper repair, installation of non CALIMET approved parts, accessories, or components. **This device must be send to the warrantor at the consumer's expense to:**

CALIMET CO., INC.
9949 HAYWARD WAY
SOUTH EL MONTE, CA 91733

The warrantor will return the repaired or replaced unit to the customer at the consumer's expense.

The limited warranty does NOT cover labor fees for reinstalling a repaired or replaced unit or part.

These warranties are in lieu or all other warranties either expressed or implied, and CALIMET CO., INC. shall not be liable for consequential damage. All implied warranties of merchantability and/or fitness for a particular purpose are hearby disclaimed and excluded. This limitation is not valid in jurisdictions which do not allow limitation of incidental or consequential damages or limitation of warranty periods. Please complete the registration card and send it by mail within 30 days of purchasing from CALIMET, DEALER or your INSTALLER. If not registered only a one (1) year warranty on all part will be provided.

The warranty card must be mailed to the address listed on the card with the proof of purchased (Invoice). Alternatively, the warranty can be completed online at <https://calimetco.com/warranty> and email us your proof of purchased (Invoice) with Email Subject: Full Name, Model #, Serial #.

CALIMET

CALIMET CO., INC.
9949 HAYWARD WAY, SOUTH EL MONTE, CA 91733
626.452.9009 | INFO@CALIMETCO.COM | CALIMETCO.COM

