

CALIMET

Access Control Systems

M6

Swing Gate Operator

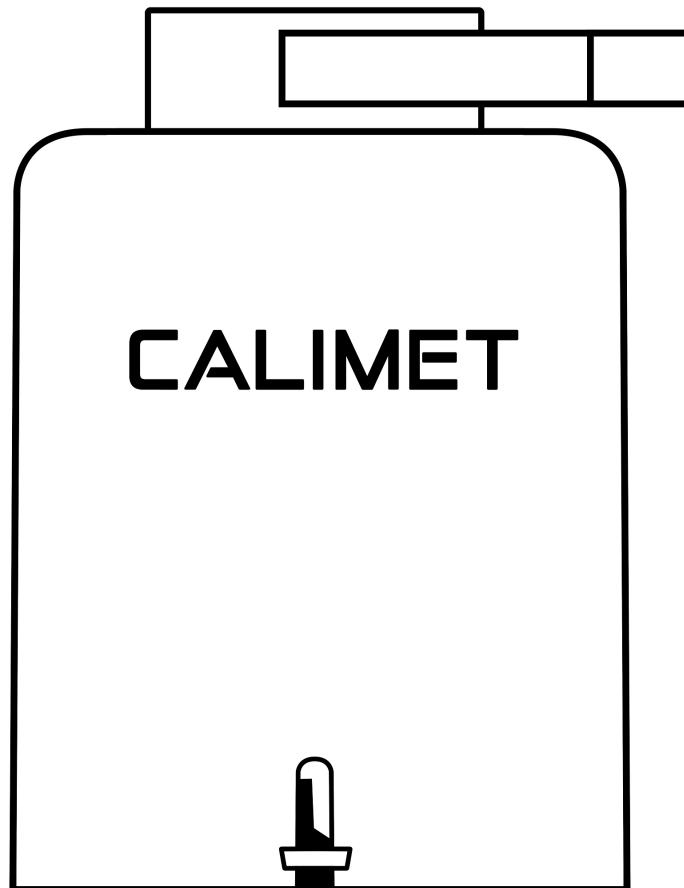

Installation and Owner's Manual

TABLE OF CONTENTS

OVERVIEW	Gate Operator Overview.....	2
	Safety.....	3-5
	Property Types & Entrapment Protection.....	6

INSTALLATION	Before Installation.....	7
	Step 1: Standard Installation.....	8
	Step 2: Install a Concrete Pad.....	9
	Compact Installation.....	10
	Swivel Arm Positioning Tips.....	11
	Step 3: Weld the Door Arm.....	12
	Step 4: Connecting the Power.....	13
	Step 5: Open Direction.....	14
	Step 6: Install the Photocell Sensor.....	15-17
	Step 7: Adjust the Gate Travel Limits.....	18
	Step 8: Force Adjustment.....	19
	Step 9: Install Warning Signs.....	20
	After installation.....	21

FEATURES	Dual Gate Setup.....	22
	Emergency Release.....	23
	Dip Switch Features, Speed.....	24-25
	Circuit Board Layout.....	26-27

ACCESSORY WIRING	Remote Controls.....	28
	Exit Loops.....	29-31
	Accessory Wiring.....	32
	Locks, Receivers, Photocell Sensors.....	33
	Safety Edge, Fire Box, keypad, Access Controllers.....	34
	Battery, Solar Panel.....	35

TROUBLESHOOTING	Circuit Board Light Status Chart / Alarm Sounds.....	36
	Troubleshooting.....	37-38
	Maintenance.....	39
	Warranty.....	40
	Notes.....	41

GATE OPERATOR OVERVIEW

Power Input	110-120V AC, CM6-DCFP/DCFP-S: 15 Amps,CM6-ACFP: 30 Amps
System Operating Voltage	CM6-DCFP: 24V DC
Maximum Output Current	15 Amp, Fuse: 24V DC 15 Amp
Dimensions	16.5" x 20" x 24"(L x W x H)
Gate Type	Swing
Application	Residential/Commercial
Maximum Gate Weight	1000 lbs
Maximum Gate Length	18 Feet
Operating Temperature	-4°F to 140°F
Maximum Gate Travel Speed	Approximately 20 sec for 90° opening, Adjustable Speed
Maximum Duty Cycle	Continuous
Inherent Entrapment Protection	Inherent Reverse Sensor System (Type A)
External Entrapment Protection	Photoelectric Sensor (Type B1)
Solar Ready	CM6-ACFP: No, CM6-DCFP/DCFP-S: Solar Ready
Emergency Release	Foot Pedal Manual Release
Property Class	I, II, III, IV
Warranty	5 Year Residential, 3 Year Commercial

PARTS LIST

Calimet Gate Operator, Swivel Arm, 2 Remote Controls, Photosensor and Reflector, Photosensor Mount (x2), Warning Sign (x2), Allen Wrench, Bolts (x6), Instruction Manual, Warranty Card

CM6-DCFP: Battery, Battery Circuit Board

CM6-DCFP-S: Battery, Battery Circuit Board, Extended Solar Battery, Solar Panel (x2)

Safety

Carefully read, follow, and accept all safety precautions and warnings before attempting to install and use a gate operator, incorrect installation can lead to severe injury or death.

- The gate operator must be installed by a trained gate technician; otherwise serious personal injury or property damage may occur.
- Installing a gate operator may require installation of standard 110V-120V AC electrical wiring. This work should only be performed by an experienced electrician. Miswiring could cause personal injury or DEATH.
- Never let children operate the gate or play around the gate. Keep the remote control away from children.
- Always keep people and objects away from the gate. Cars, people, and other objects should never enter when the gate is closing.
- Verify that this operator is proper for the type, weight, and size of the gate.
- Make sure the gate has been properly installed and swings freely in both directions with no resistance. Repair or replace all worn or damaged gate hardware prior to installation.
- Test gate operator monthly. The gate must reverse when it comes in contact with a solid object, or stop when an object activates the non-contact sensors. After adjusting the force or travel limit, re-test the gate operator. Failure to maintain the gate operator properly can increase the risk of injury or death.
- Use the emergency release only when the gate is not moving.
- Keep the gate and gate operator properly maintained. Read the maintenance section of this manual and follow the maintenance schedule. Have a certified service technician make repairs or install gate operator hardware.
- Gate operators can use a huge amount of force to open and close a gate. Therefore, safety features must be taken into consideration when installing and using a gate operator. Specific safety features include: photoelectric sensors, edge sensors (contact), moving gate warning signs, guards for exposed rollers, screen mesh, vertical posts, and more.
- The gate must be installed in a location so that enough clearance is supplied between the gate and adjacent structures when opening and closing to reduce the risk of entrapment.
- Entrapment is defined as when a person, vehicle, or object is caught or held in a position that increases the risk of injury.
- Access controls intended for users must be located at least 6 feet (1.8m) away from any moving part of the gate and where the user is prevented from reaching over, under, around, or through the gate to operate the controls.

Safety

- A minimum of two (2) warning signs shall be installed, one on each side of the gate that is easily visible.
- The gate must have sufficient room when opening and closing. Swinging gates should open inwards and not into public access areas. The gate must be properly installed and move freely in both directions.
- Install the gate operator only when: 1) The operator is appropriate for the construction of the gate and the usage class of the gate, 2) All exposed pinch points are eliminated or guarded.
- For gate operators utilizing Type D protection: 1) The gate operator controls must be placed so that the user has full view of the gate area when the gate is moving, 2) The placard shall be placed adjacent to the controls, 3) An automatic closing device (such as a timer, loop sensor, or similar device) shall not be employed, and 4) No other activation device shall be connected.
- The gate operator is intended for installation only on vehicular gates. Pedestrians must access a separate entrance. The pedestrian entrance shall be designed for pedestrian usage. The gate must be installed in a location so that pedestrians will not come in contact with the vehicular gate during the entire path of travel of the vehicular gate.
- For gate operators utilizing a non-contact sensor, see instructions on the placement of non-contact sensors for each Type of application, 2) Care shall be exercised to reduce the risk of nuisance tripping, such as when a vehicle, trips the sensor while the gate is still moving, and 3) One or more non-contact sensors shall be located where the risk of entrapment or obstruction exists, such as the perimeter reachable by a moving gate or barrier.
- For a gate operator utilizing a contact sensor, one or more contact sensors shall be located at the leading edge, trailing edge, and post mounted both inside and outside of a vehicular gate. 2) One or more contact sensors shall be located at the bottom edge of a vehicular vertical lift gate. 3) One or more contact sensors shall be located at the pinch point of a vehicular vertical pivot gate. 4) A hardwired contact sensor shall be located and its wiring arranged so that the communication between the sensor and the gate operator is not subjected to mechanical damage. 5) A wireless contact sensor such as one that transmits radio frequency (RF) signals to the gate operator for entrapment protection functions shall be located where the transmission of the signals are not obstructed or impeded by building structures, natural landscaping or similar obstruction. A wireless contact sensor shall function under the intended end-use conditions.

Safety

- Controls intended to be used to reset an operator after 2 sequential activations of the entrapment protection device or devices must be located in the line-of-sight of the gate. Outdoor or easily accessible controls shall have a security feature to prevent unauthorized use.
- Keep these instructions.

Property Types & Entrapment Protection

Required Entrapment Protection

- A - Inherent (built-in) Entrapment protection System
- B1 - Non-contact sensor such as a photo-eye or equivalent
- B2 - Contact sensor such as edge sensor or equivalent
- C - Inherent adjustable clutch or pressure relief device
- D - Actuation device requiring continuous pressure to maintain gate motion
- E - Inherent Audio Alarm

Class I - Residential

Intended for use in a home of one to four single family dwellings, or garage or parking area associated therewith.

Swing Gate Requirements: Primary Device: A, C | Secondary Device (one required) A, B1, B2, C, D

Class II - Commercial

Intended for use in a commercial location or building such as a multi-family housing unit (five or more single family units, hotel, garages, retail store or other building servicing the general public.

Swing Gate Requirements: Primary Device: A, C | Secondary Device (one required) A, B1, B2, C, D

Class III - Industrial

Intended for use in an industrial location or building such as a factory or loading dock area or other locations not intended to service the general public.

Swing Gate Requirements: Primary Device: A, B1, B2, C | Secondary Device (one required) A, B1, B2, D, E

Class IV- Restricted Access

Intended for use in a guarded industrial location or building such as a military base, hazardous chemical sites, or other restricted access location not servicing the general public, in which unauthorized access is prevented via supervisions by security personnel.

Swing Gate Requirements: Primary Device: A, B1, B2, C, D | Secondary Device (one required) A, B1, B2, C, D, E

NOTE: A minimum of 2 independent entrapment protection devices are required for each direction of travel. The same type of device shall not be utilized for both the primary and secondary entrapment protection means. Use of a single device to cover both the opening and closing directions is in accordance with the requirement; however, a single device is not required to cover both directions.

Before the Gate Operator Installation

Gate Structure

Confirm that the gate operator being installed is appropriate for the gate type, weight and size. The gate should be mounted and moving freely. There should be little resistance in the movement of the gate. The gate and post must be suitable for being automated. Check that the structure is sufficiently strong and stable, and that its dimensions and weights conform to those listed in the specifications table of this document. Any worn or damaged gate hardware must be repaired or replaced before installing the gate operator.

Vehicular gates are to be constructed and installed in accordance with the ASTM F2200 construction standards.

Electricity

The CM6 is powered by 110V-120V AC power. If you have not already done so, and you are not using solar, wire a waterproof outlet near the gate following proper safety standards for your area. If you are not experienced with this type of wiring or if your area requires it, hire a professional electrician to perform this as well as wire in the CM6 gate operator. Make sure your electrician takes into account the voltage drop involved in running many feet of wire to your installation location. If an insufficient gauge of wire is used, the gate operator may have insufficient power.

The gate operator must be disconnected from the power source before the installation. This also includes gate operator accessories.

Step 1: Standard Installation

Refer to the illustrations below to determine the measurements of the gate operator and concrete pad.

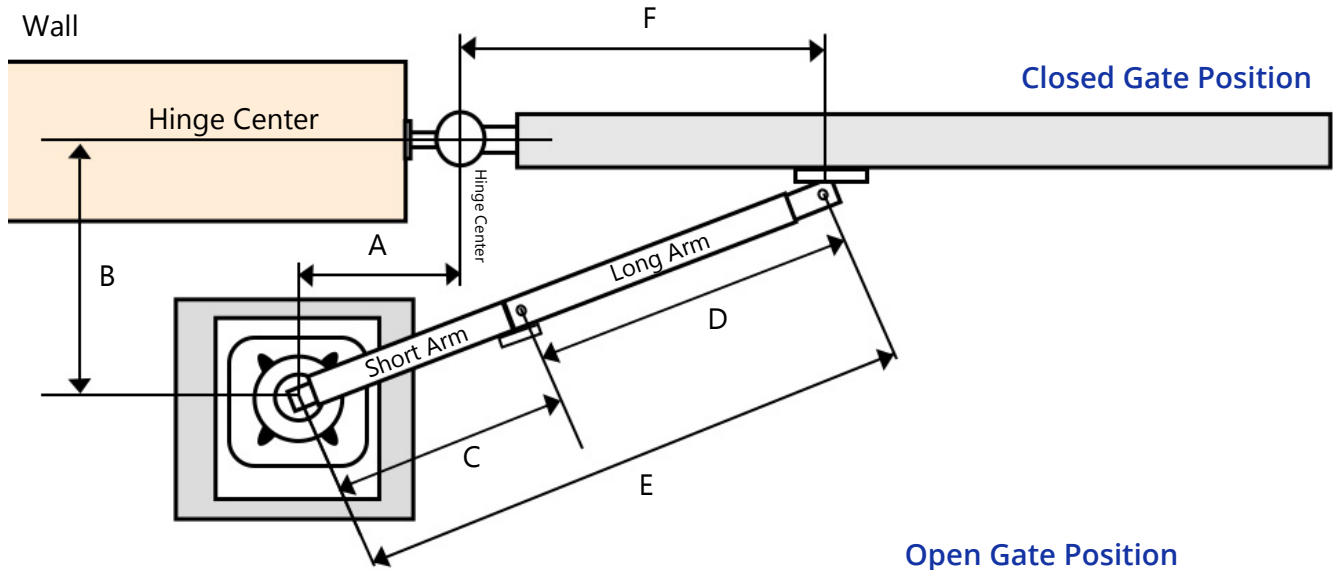

A. 14" minimum

B. 27" minimum

C. Length of C = $E * 40\%$.

The length of C is 40% of E. Arm should be 90° from gate when open and straight when closed. Distance from the center of the gate operator output shaft to the swivel arm nut. Note: C is the short part of the swivel arm.

D. Length of D = $E * 60\%$.

The length of D is 60% of E. Arm should be 90° from gate when open and straight when closed. Distance from the swivel arm nut to the center of the gate bracket. Note: D is the long part of the swivel arm.

F. If the gate length is less than 10 feet, F should be at least 1/4 the gate length.

If the gate length is greater than 10 feet, F should be at least 1/3 the gate length.

For uphill or heavy gates, F should be at least 1/3 gate length.

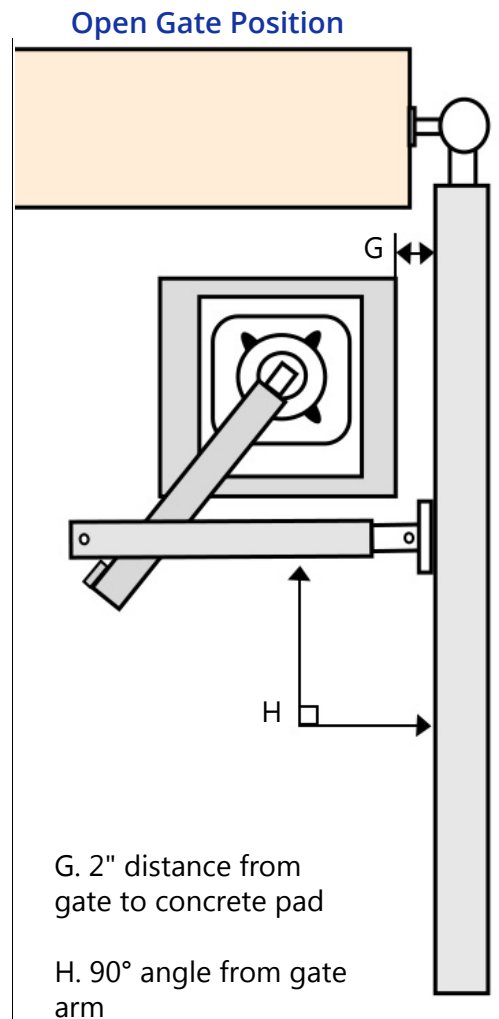

G. 2" distance from gate to concrete pad

H. 90° angle from gate arm

Step 2: Install a Concrete Pad

1. Lay out a concrete pad. Requires a minimum of 21"(length) x 24"(width) x 24"(20" depth below ground, 4" above ground). See Step 1 for the position of the concrete pad.
2. Install the electrical conduit. One conduit is required for a single gate. For double gates, add another conduit. For underground loops, add another conduit.
3. Pour the concrete pad.
4. Use 4 wedge anchors 1/2" to secure the gate operator to the concrete. Figure A

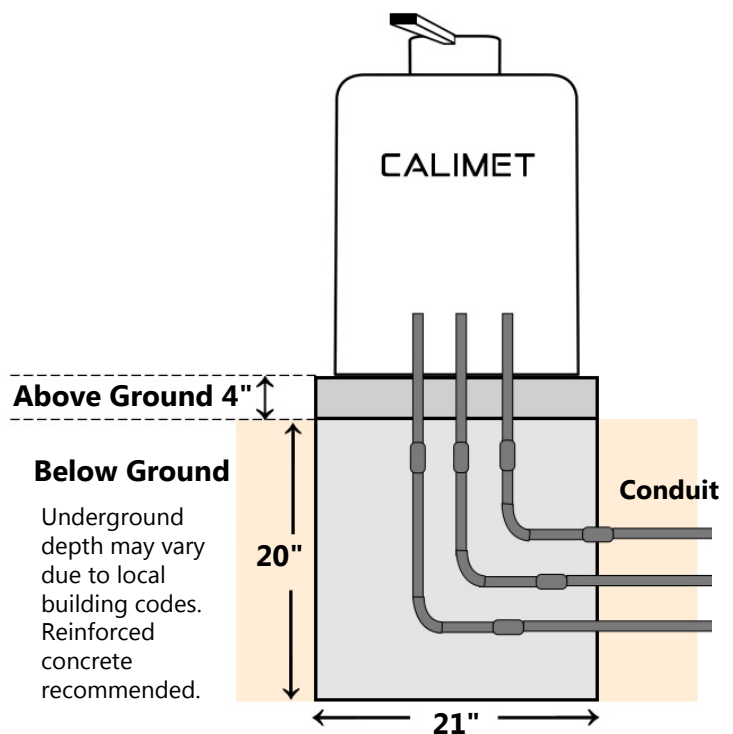
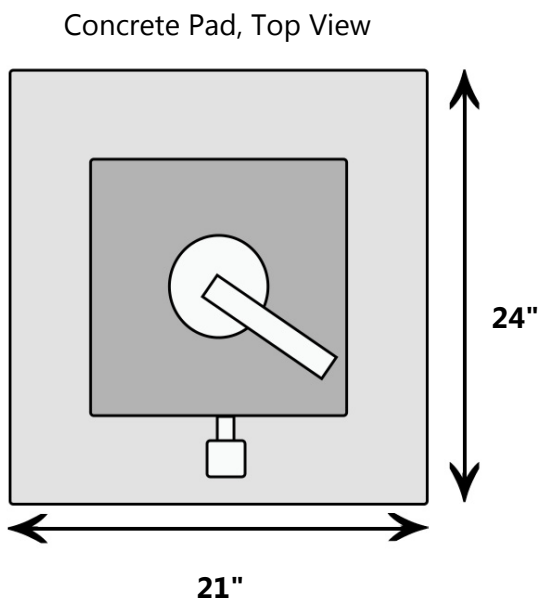

Conduits should be 6-12" apart from one another to avoid interference.

CAUTION

Call 811 for digging information or contact local underground utility locating companies before digging more than 12 inches deep to avoid damaging underground power, gas, or other utility lines.



Figure A
Wedge Anchor
1/2"

Compact Installation

Install using compact installation ONLY when the space between the OPEN gate and wall is between 20-32", Figure A.

1. Cut the swivel arm to meet the size requirements. Figure B

Figure A: Open Gate Position

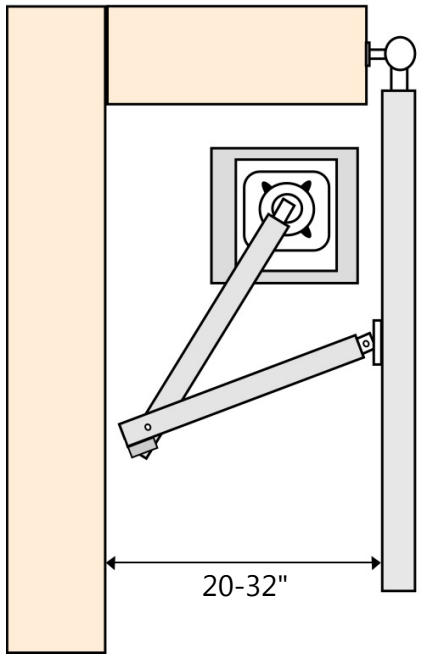
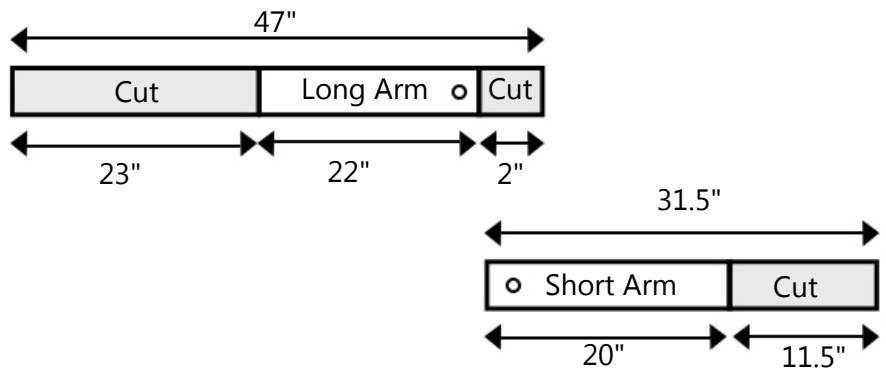
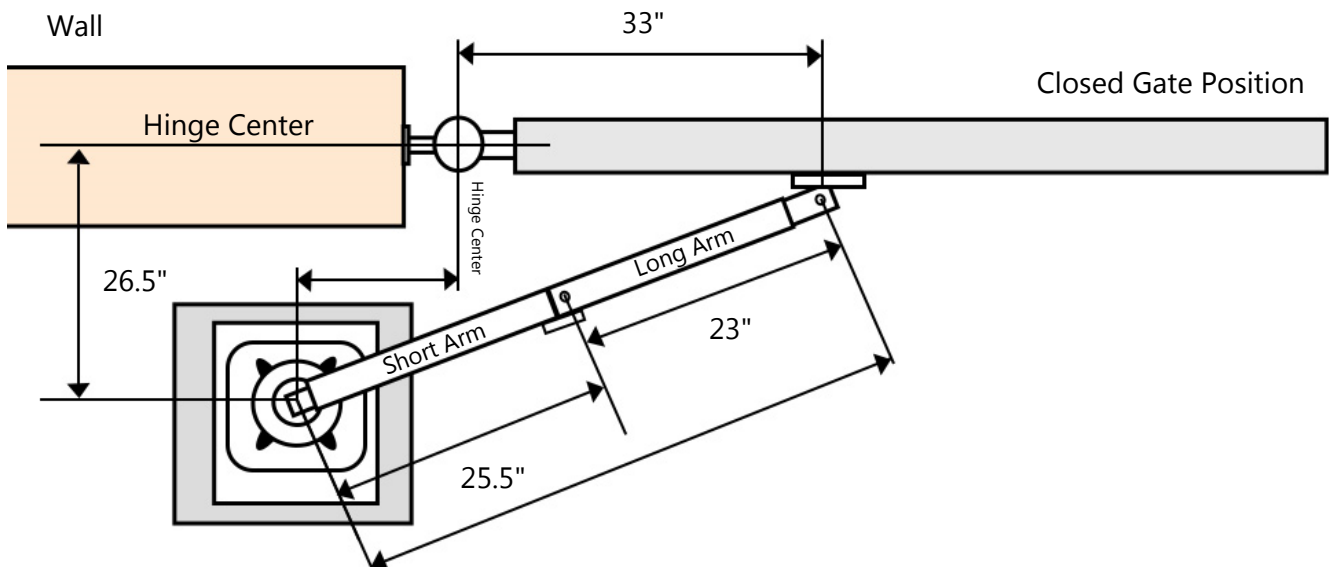

Figure B: Cut the Swivel Arm



2. Install the swivel arm in accordance to the measurements below.



Swivel Arm Positioning Tips

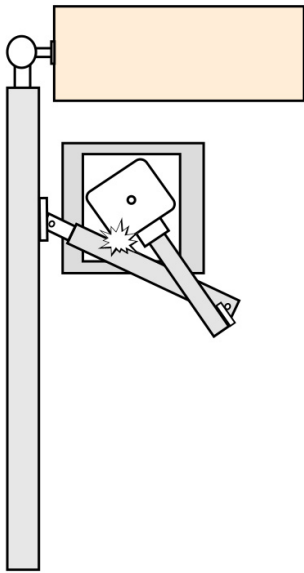

Figure A

A. DO NOT allow the arm to touch the gate operator's hood when the gate is in the open position.

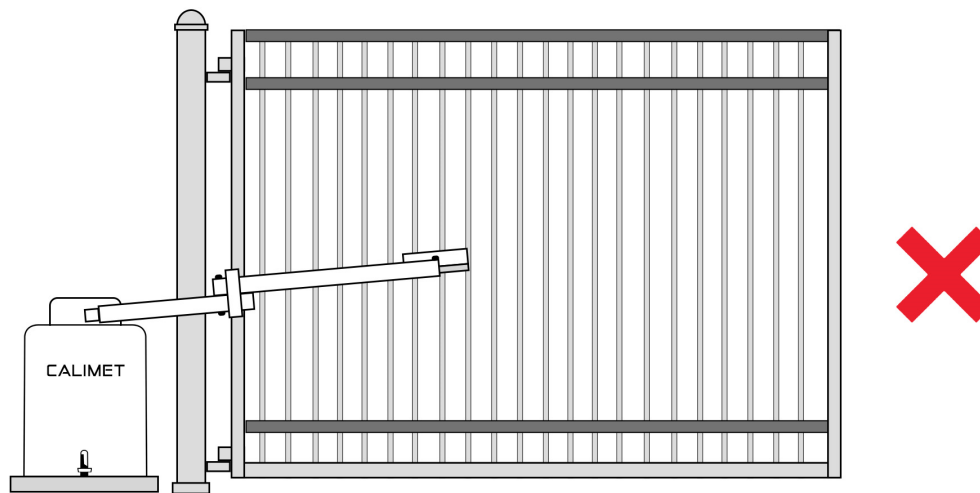
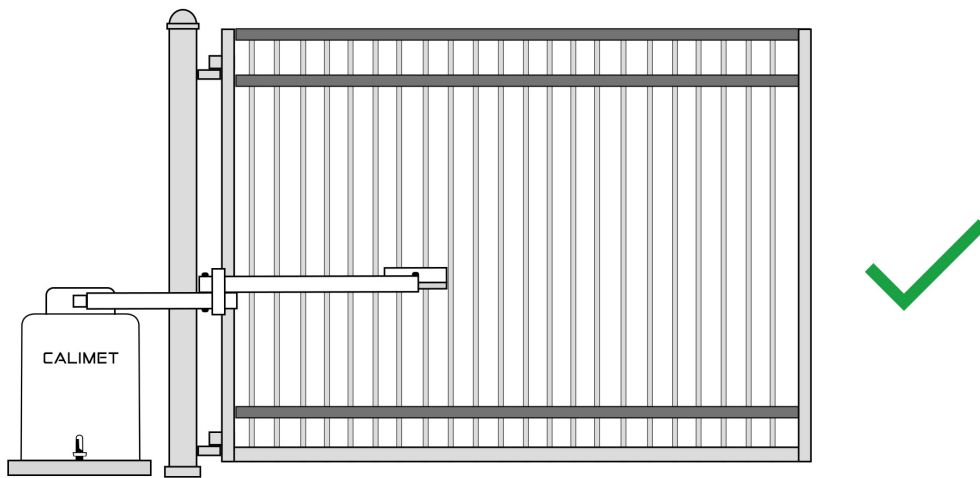
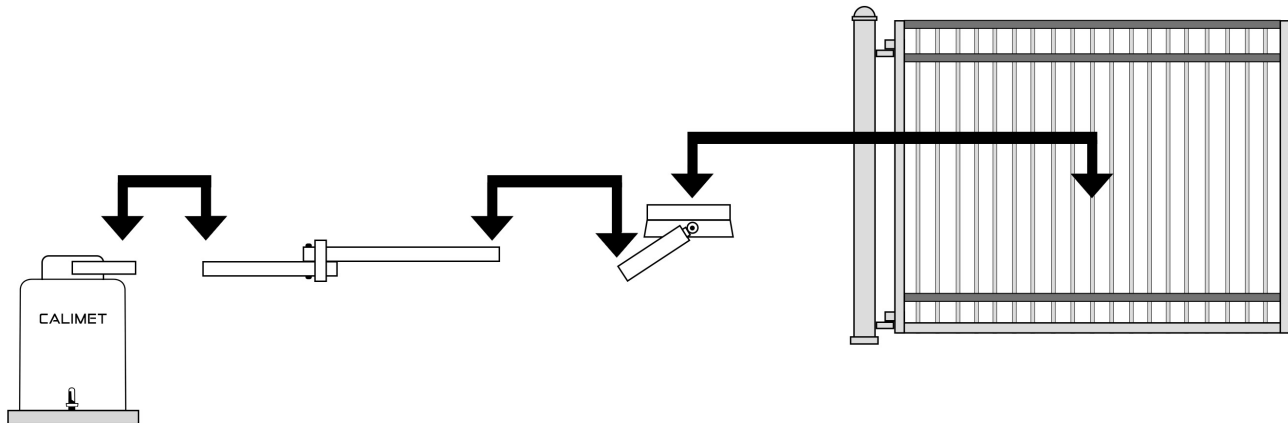

Figure 8: Swivel arm is incorrectly bent. Swivel arm must be straight.

Step 3: Weld the Gate Arm



! **IMPORTANT** If you already jumped ahead to step 4 on the next page and connected the power cables, disconnect the power cables before welding. **DO NOT** weld while the power cable is attached to the gate operator.

After you're satisfied with testing the arm in the full open and closed positions, weld the following:

1. Short arm to gate opener metal bar
2. Gate bracket to gate
3. Gate bracket to long arm

Step 4: Connecting the Power

1. Use UL approved electrical wires, stranded copper, connected to 110-120V AC electricity. Electrical wires **MUST** have a minimum capacity for 15 Amp current. See Figure A below for the correct electrical wire gauge size. Wires must be placed in a PVC or other underground conduit.
2. Turn off the AC power from the main power source circuit breaker.
3. Connect the green wire to the green wire (GROUND) wire using a wire nut (Figure B).
 - a. Alternative: connect the green wire to the earth ground rod and AC ground wire nut. Note: The earth ground rod can be grounded to the chassis.
4. Connect the white wire to the white wire (NEUTRAL) using a wire nut.
5. Connect the black wire to the black wire (HOT/LINE) using a wire nut.

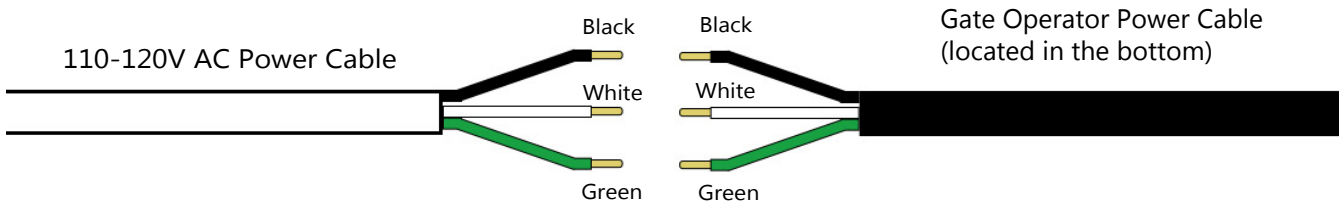

6. All operators **MUST** be properly grounded in order to prevent an electrical charge. Must use a dedicated circuit for power supply.
7. Turn ON AC power from the main power source.
8. Turn the power switch on the gate operator to the ON position. For DCFP and DCFP-S model gate operators, turn the battery switch to the ON position, Figure C

Electrical Wire Gauge Chart

Distance	Gauge
0 - 200 ft	14 AWG
201-400 ft	12 AWG
401-650 ft	10 AWG
651-1000 ft	8 AWG
1001-2000 ft	4 AWG

Figure A

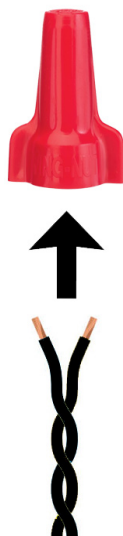

Figure B

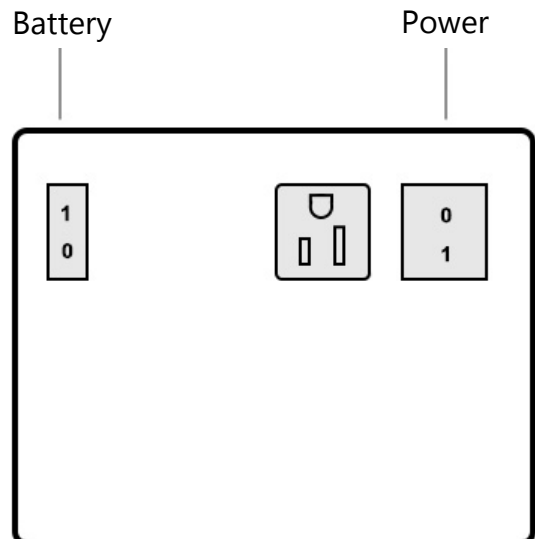

Figure C

Step 5: Set the Gate Open Direction

Determine which direction your gate opens when viewed from the inside

Dip Switch #6 (Figure A) on the bottom of the gate operator circuit board controls the open direction.

- ON = opens to the right
- OFF = opens to the left

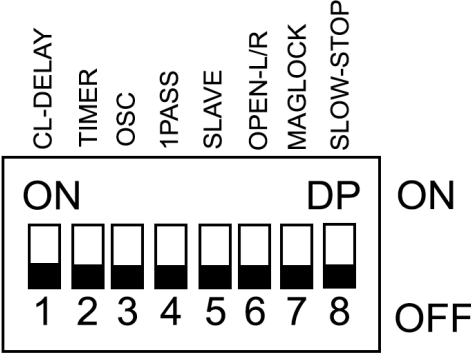
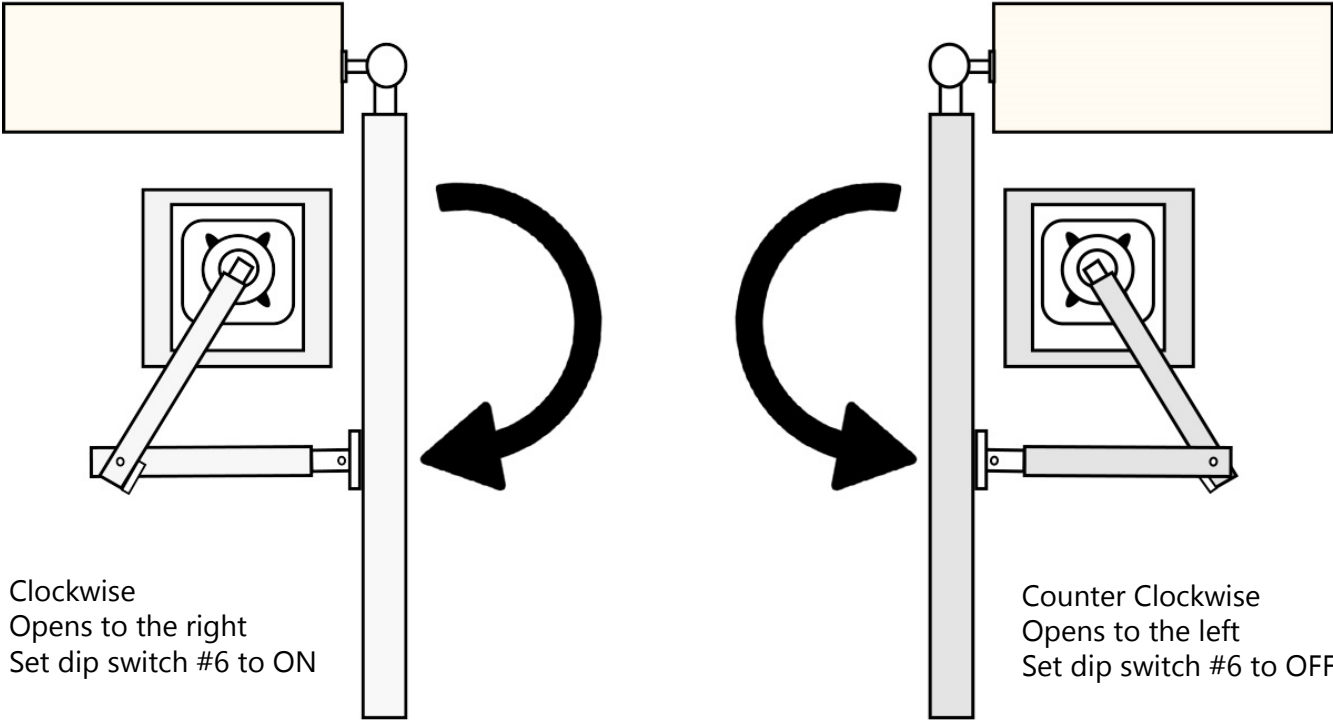
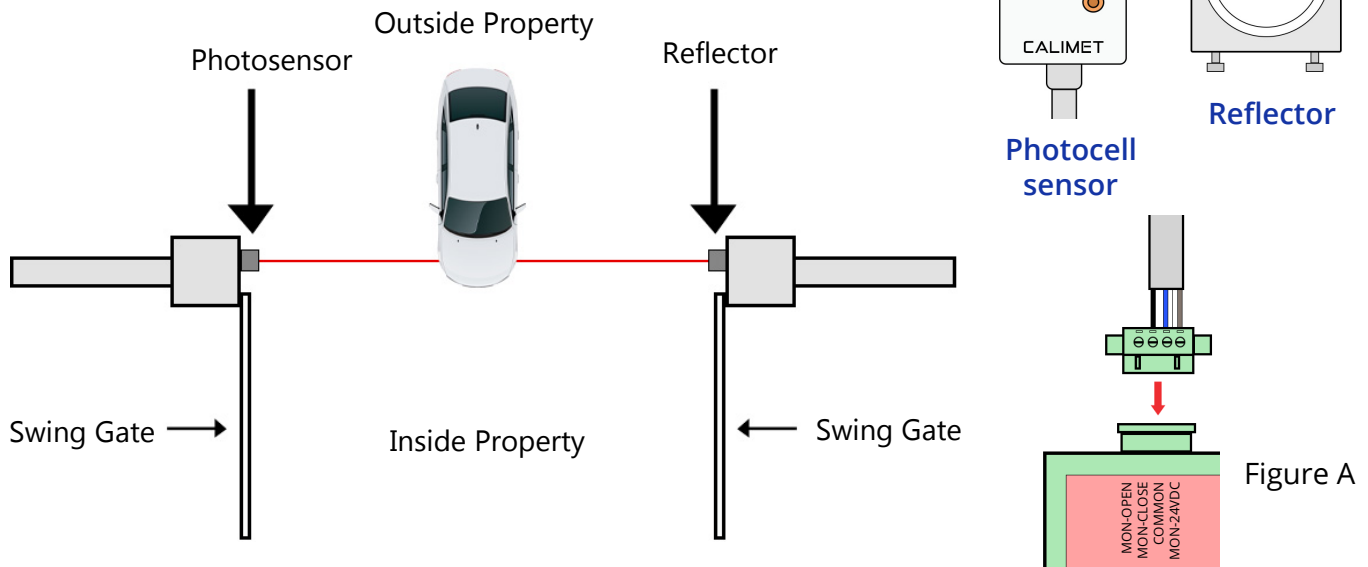

Figure A



Step 6: Install the Photocell Sensor

The photocell sensor is a safety device that prevents the gate from hitting a vehicle or pedestrian when the gate is closing. The photocell sensor emits an invisible retroreflective infrared beam that detects when objects pass through.



1. Plug the photocell sensor cable to the back of the gate opener, behind the circuit board with a green input with the label: "MON-OPEN, MON-CLOSE, COMMON, MON-24VDC". Figure A
2. Press the reset button on the gate operator circuit board.
3. Use the two included mounting brackets to mount the photocell sensor on a post or wall OUTSIDE your gate, 21" from the ground.
4. Press the orange button on the photocell sensor to turn on the alignment laser.
5. Mount the reflector to the opposite side. Make sure the alignment laser hits inside the circle of the reflector. Figure B, Figure C
6. Press the orange button on the photocell sensor to turn off the alignment laser. Important! Alignment laser must be off. Figure D

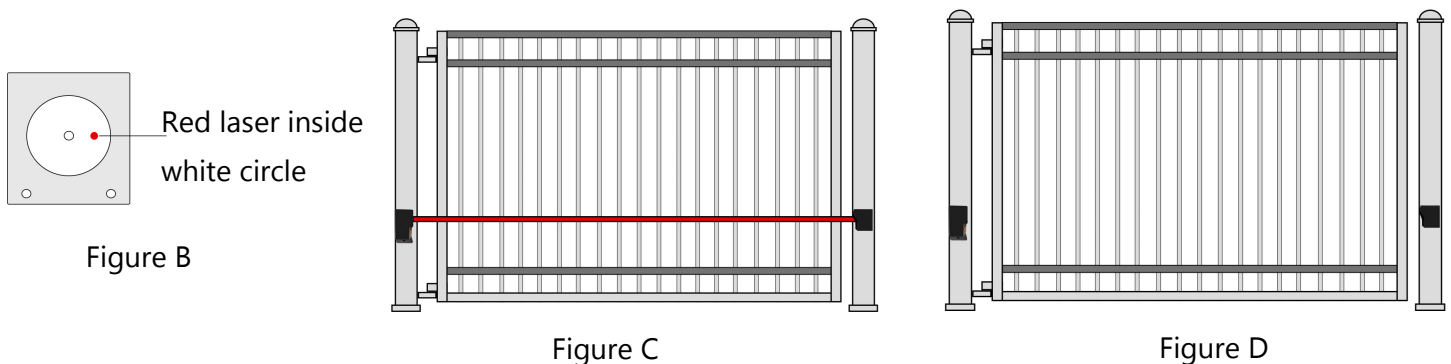

Photocell Sensor Wiring

The sensor is already pre-wired. Use the below wiring diagrams only as a reference if you need to make changes. Some photocell sensors may have 3 or 4 wires.

3-Wire Wiring Diagram	
Gray	MON-CLOSE
Blue	COMMON
Brown	MON-24VDC

4-Wire Wiring Diagram	
Black	MON-CLOSE
Blue and White	COMMON
Brown	MON-24VDC

Photocell Sensor LED Indicators

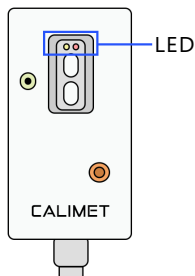

LED INDICATORS	
Yellow and Red On	Relay is energized and signal is aligned and stable
Yellow Off Red On	Relay is energized, reflector is on the edge of the signal path
Yellow and Red Off	Beam is obstructed or sensor is not aligned with the reflector

Notes

- The default photocell sensor range is 30'. For a longer range, upgrade to the CM9-487, which has a max range of 50'.
- The photocell sensor cannot be used for a detection area less than 0.5'.
- If you need to place the photocell sensor further away, extend the photocell sensor wires by joining (splicing) with another 20-22 AWG wire.

Installing a secondary Photocell Sensor (Optional)

A second photocell sensor can be installed inside the gate to monitor the OPEN cycle.

This secondary photocell sensor goes inside your property, past the gate's fully open position. If the photocell sensor's cable isn't long enough you will need to extend (splice) the wires by joining them with another 20-22 AWG wire for the secondary photocell sensor to be able to reach the gate operator input.

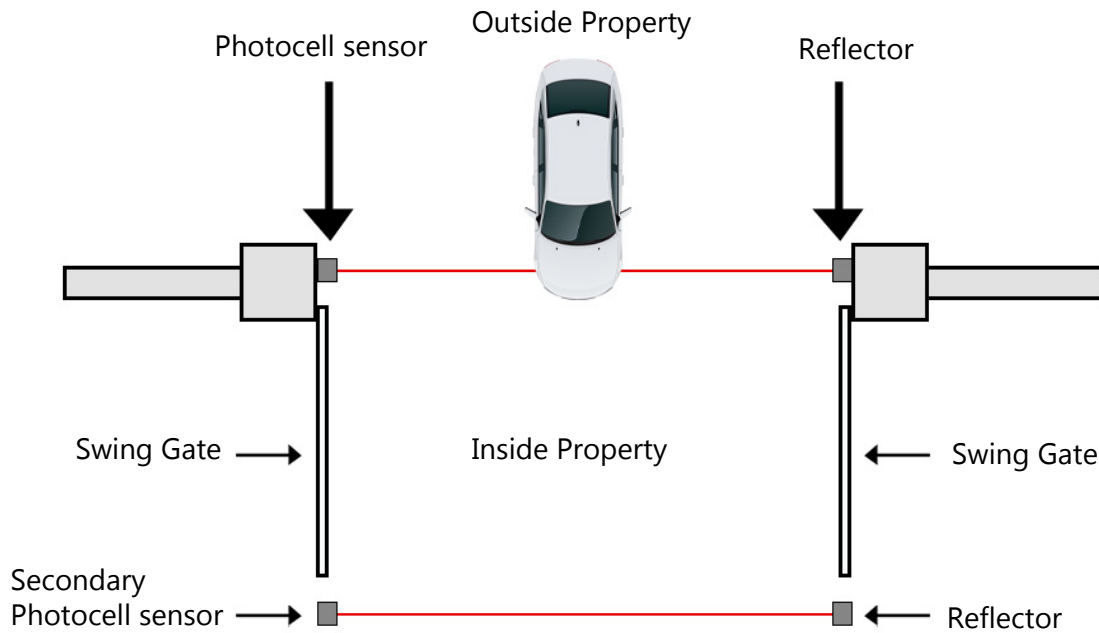

Secondary Photocell Sensor Wiring

Use the same green terminal block input as your primary photocell sensor. Each input can have more than 1 wire inserted.

Different model photocell sensors contain 3 or 4 wires. Depending on how many your photocell sensor contains, follow the wiring diagram below.

4 Wires:

- Red/Brown > MON_24VDC
- Blue and White > COMMON
- Black > MON_OPEN

3 Wires:

- Red/Brown > MON_24VDC
- Blue > COMMON
- Gray > MON_OPEN

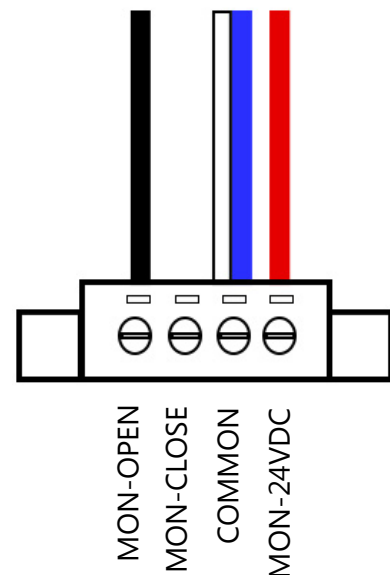

Step 7: Adjust Gate Travel Limits

The gate travel limit controls the position of where the gate opens and closes.

1. Use a screwdriver to loosen the 3 screws on the top limit cam. Do the same for the bottom limit cam.

TIP: For the next step below, use the OPEN, CLOSE, STOP buttons on the circuit board for efficient positioning. Press the STOP button before the gate hits the end. The gate should stop about 1/2 an inch before it hits the end. The gate should not touch the end of the wall or post.

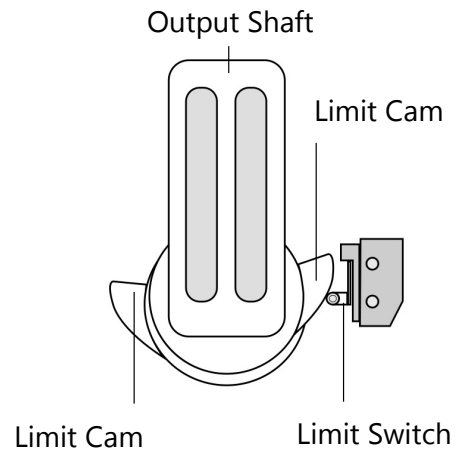

2. If gate opens to the right (clockwise):

The top limit cam controls the open limit

- Turn the top limit cam counter clockwise to increase open distance ↺
- Turn the top limit cam clockwise to decrease open distance ↻

The bottom limit cam controls the close limit

- Turn the bottom limit cam clockwise to increase close distance ↻
- Turn the bottom limit cam counter clockwise to decrease close distance ↺

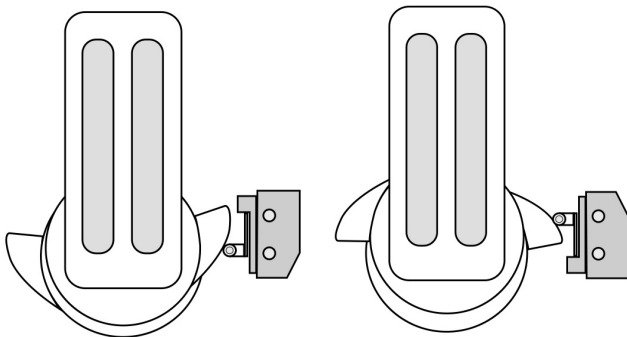

Top limit Cam,
Gate fully opened

Bottom Limit Cam,
Gate fully Closed

2. If gate opens to the left (counter clockwise):

The top limit cam controls the close limit

- Turn the top limit cam counter clockwise to increase close distance ↺
- Turn the top limit cam clockwise to decrease close distance ↻

The bottom limit cam controls the open limit

- Turn the bottom limit cam clockwise to increase open distance ↻
- Turn the bottom limit cam counter clockwise to decrease open distance ↺

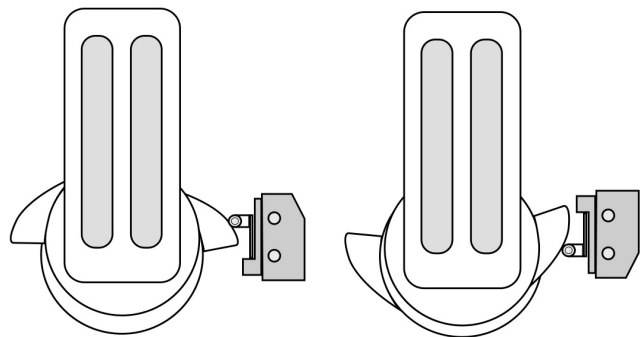

Bottom Limit Cam,
Gate fully Opened

Top Limit Cam,
Gate fully Closed

3. Use the screwdriver and screw back in the limit cam screws.

Step 8: Force Adjustment

The Electronic Reversing Device (ERD) is a feature on the circuit board which detects when the gate comes in contact with an obstruction, causing the gate to reverse. These are the 2 blue knobs on the circuit board.

The open and close knobs determine the amount of force required to reverse the gate (figure A). We generally recommend leaving the knob at 50. You may adjust the positions based on your particular gate.

If the gate reverses without touching an obstruction, the ERD is set too low. If the gate does not reverse when it hits an obstruction, the ERD is set too high.

Test ERD every 6 months.

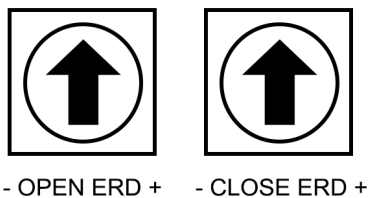
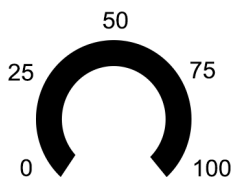

FIGURE A

Normal = 50 is the default ERD force and is suitable for most gates

Turn Left/Counter-Clockwise = Less force to stop the gate.

Turn Right/Clockwise = More Force required to stop the gate.



Obstruction Test

1. Place a light object (ex. chair or trash can) between the open gate and the post.
2. Close the gate. The gate should stop and reverse when it touches the object. If the gate does not reverse when it touches the object, press the STOP button on the circuit board. Reduce the ERD force by turning the CLOSE ERD knob counter-clockwise.
3. Do the same test again for the open direction.
4. Test the gate operator after any adjustments are made.

WARNING

- Never increase force beyond the minimum amount required to move the gate. Too much force may seriously injure or kill people.
- Never use force adjustments to compensate for a improperly installed, improperly maintained, or a damaged gate. The gate must normally move freely with no obstructions.
- The ERD must be tested after making any changes. The gate must reverse when it comes in contact with an object.

Step 9: Install Warning Signs

Warning signs are to alert people that a possible hazard exists with moving gates, so that appropriate action can be taken to avoid injury.

Install the 2 supplied warning signs in locations where the signs are visible by people on both sides of the gate. They may be installed directly on the gate, or a nearby wall or post.

Use screws (not supplied) to install the warning signs.



Finished! You are now finished installing your gate operator.

See the next page for post-installation instructions.

After Installation

Accessories

Additional accessories such as keypads, exit loops, and access controllers can be purchased and installed to your gate operator. Ask your dealer or distributor for more information or visit calimetco.com/accessories to view all available accessories.

Warranty

Register your warranty using the warranty card included in the box. This will require the serial number of the gate operator which is located underneath the black cover, outside the circuit board compartment. After you're done, mail in your warranty to the address specific on the card.

Additionally, you may register your warranty online by visiting calimetco.com/gate-operator-warranty-registration.

Auto-Close Timer

Most homeowners prefer the gate to close automatically after they drive through it. See the "Dip Switch Features" page, specifically the "2. Timer" section to set up the auto-close timer on your gate operator.

Dual-Gate Installation

For double gates, visit the "Dual Gate Setup" page for more installation instructions.

HomeLink / Car Setup

Most modern cars come with a feature called Homelink that lets you open your gate by pressing a button on your car. Calimet gate operators are compatible with HomeLink. Visit homelink.com/program/vehicle and enter your car model to view specific instructions. For older cars, or cars with software that isn't Homelink, check your car's manual for setup instructions.

Safety

Read this instruction manual to learn the common features of a gate operator and their functions. Learn how to turn off the power and how to use the emergency release pedal in cases of a power outage. Keep your gate maintained by following the "maintenance" page instructions.

Read the "Safety" page to learn the dangers of a moving gate. Educate all individuals on the property of the dangers of a moving gate. Keep all children away from moving gates. Do not allow children to play on or near the gate or operate the remote controls.

Installers

Fill out the "notes" page with the gate operator model and serial number and provide them with your contact information.

Leave instruction manual and product literature with the owner or end user.

Dual Gate Setup

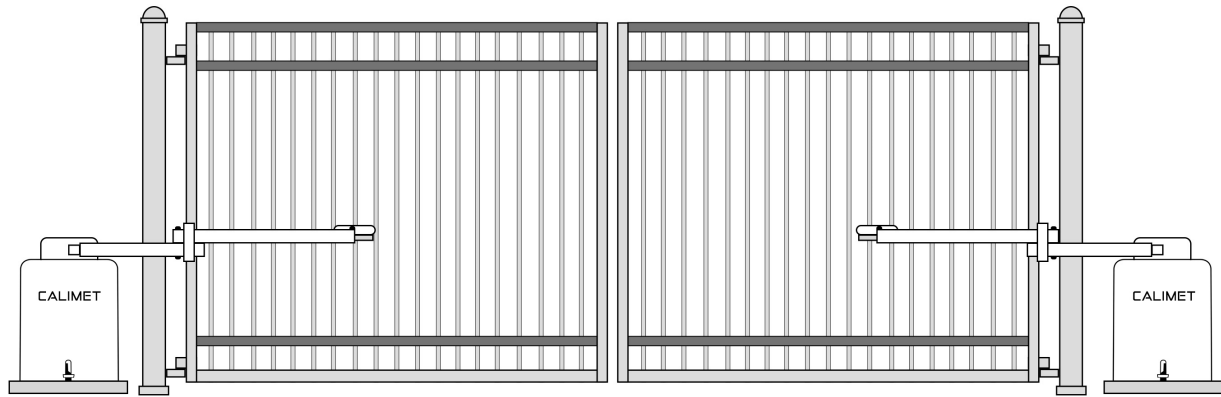

This setup is for dual swing gates. A single button press of the remote control can open both gates. This requires 2 gate operators. One gate operator is the "Primary", and the other is the "Secondary".

All accessories including remote controls, photocell sensors, loop detectors, etc., must be installed on the PRIMARY gate operator only. Only one photocell sensor is required.

1. On the Secondary gate operator circuit board, set dip switch #5 to ON (Figure 1).
2. Press the reset button on the Secondary gate operator circuit board.
3. A 18-22 gauge, 2 conductor, stranded, copper, electrical wire is required.
4. Locate the DATA- and DATA+ green terminal on the bottom left of the circuit board. (Figure 2). Use a flathead screwdriver to release the 2 locks on the top of the green terminal.
5. Using the electrical wire, connect the DATA+ on the primary gate opener, to the DATA+ on the secondary gate opener. Connect the DATA- on the primary gate opener to the DATA- on the secondary gate opener. The M/S link LED light should now be lit on both circuit boards.
6. Use a flathead screwdriver to close the two locks on the top of the green terminal.

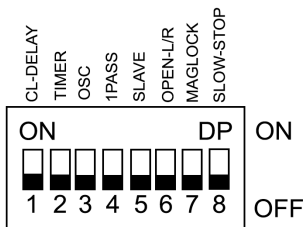

Figure 1

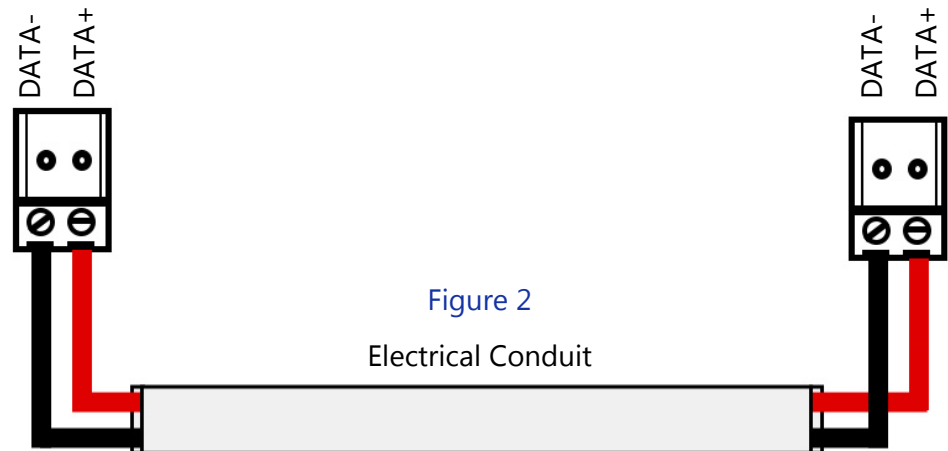

Figure 2

Electrical Conduit

7. Place the cable underground in an electrical conduit. This conduit must be separate from the main 110-120V AC electricity conduit. Finished.

Emergency Release

The emergency release foot pedal allows you to open the gate manually, such as in cases during a power outage and there is no electricity.

1. Step on the release pedal with your foot and move it down to the right until it is locked in. Figure C.

2. Push gate open using your hands.

When finished, step on the pedal and move it back to the top left. Figure B.

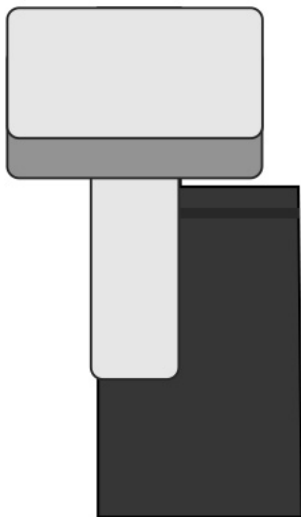
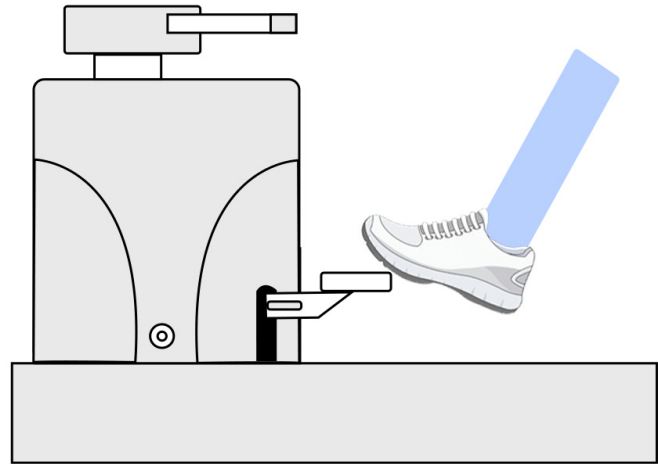

Figure B: Normal Position - Left side. The emergency release is not being used. The gate is locked in this position.

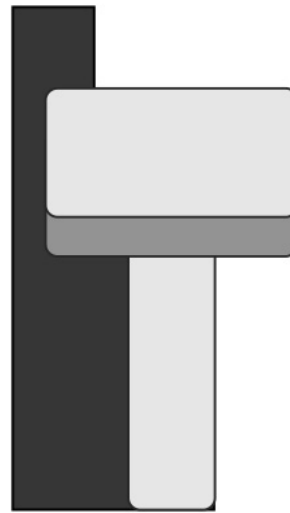

Figure C: Emergency Release - Right side. The emergency release is pressed down, allowing you to manually push open the gate.

PadLock

A padlock may be installed on the emergency foot pedal. There is a hole on the side of the pedal that allows a lock to be installed there to prevent unauthorized use of the foot pedal.

Dip Switch Features

There are 8 dip switches located at the bottom of the circuit board, Figure A. Each switch controls a different feature of the gate operator.



Figure A: DIP Switches

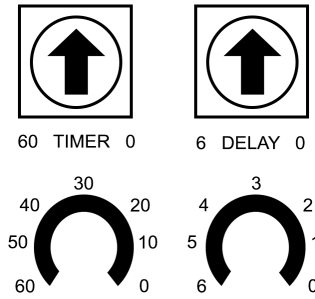

Figure B:
Timer

Figure C:
Delay

Switch	Name	Description
1	CL-DELAY	Gate Closing Delay - switch to ON position, turn timer to 1- 6 seconds. Figure C. Useful for dual gate operators with locks, requiring one gate to close first before the other, also known as "Bipart Delay".
2	Timer	Auto-Close - automatically closes the gate after a timed delay. Set to ON and turn the blue TIMER knob anywhere from 1-60 seconds. Figure B.
3	OSC	Mid-Stop - allows the remote control to stop the gate when opening or closing. Press once to stop the gate, and press the remote again to reverse the gate. Automatic Close Override - Pressing the remote control will override the close timer before the timer ends, allowing the gate to close early.
4	1PASS	Anti-Tailgating System - when ON, after a vehicle has cleared the safety loop, the gate will start to close immediately. If a second vehicle crosses the loop while the gate is closing, the gate will stop. The second vehicle must get off the loop before the gate closes completely.
5	SLAVE	Dual Gate Installation - for the secondary gate operator only, set the #5 SLAVE switch to ON. If single gate installation, set to OFF.
6	OPEN L/R	Gate Open Direction - set the direction of which the gate opens when viewed from inside the property: Left or Right.
7	Maglock	Maglock - turn on if using a magnetic lock. Wire the magnetic lock in the MAGLOCK input on the bottom left of the circuit board.
8	SLOW-STOP	Slow Stop - allows the gate to come to a slow stop when closing.

Speed

The gate opening and closing speed can be adjusted by turning the blue knob labeled "SPEED" on your gate opener circuit board. Turning left increases the speed and turning right decreases the speed.

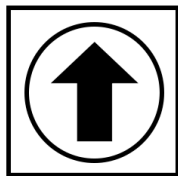

+ SPEED -



CM6-ACFP Circuit Board Layout

Gate Operator Model: [CM6-ACFP](#).

This is a picture of the circuit board. Use this for reference.

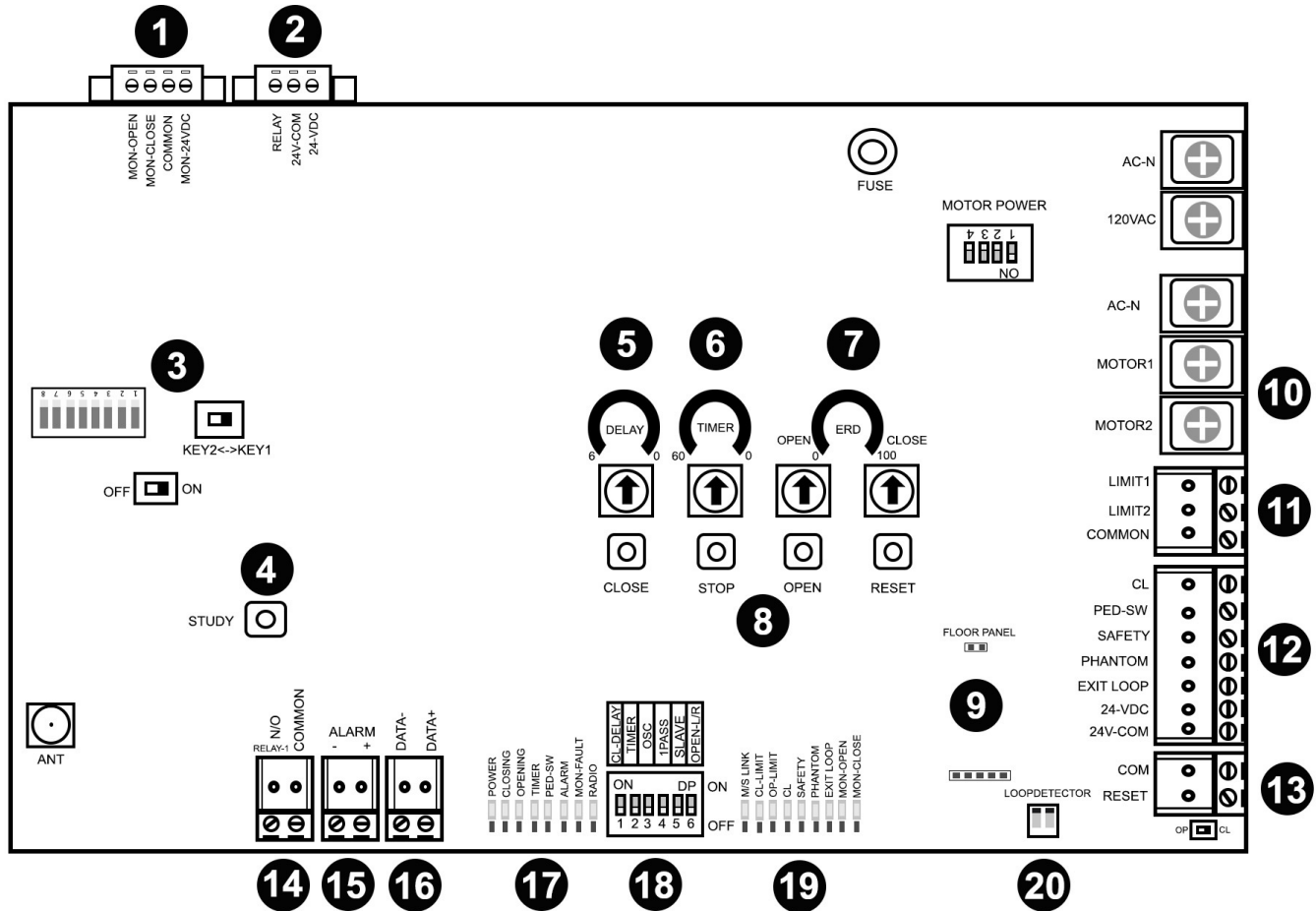

- | | |
|---------------------------------------|---|
| 1. Photocell Sensor Input | 11. Limit Switch Inputs |
| 2. External Keypad Input | 12. Loop Detectors Wire Input |
| 3. Remote Control Dip Switch Settings | 13. Common Input |
| 4. Remote Control Learn (Study) Setup | 14. Strobe Light Relay |
| 5. Delay Timer Knob | 15. Alarm Relay |
| 6. Auto Close Timer Knob | 16. Dual Gate Relay Inputs - M/S |
| 7. Open and Close ERD Knob | 17. Status Light Indicator |
| 8. Open/Close/Stop/Reset Buttons | 18. Dip Switches |
| 9. Plug-in Loop Detetcor Input | 19. Status Light Indicator |
| 10. Electric Lock Input | 20. Loop Wire Input for Plug-in Loop Detector |

CM6-DCFP Circuit Board Layout

Gate Operator Model: CM6-DCFP / CM6-DCFP-S / CM6-DCNB

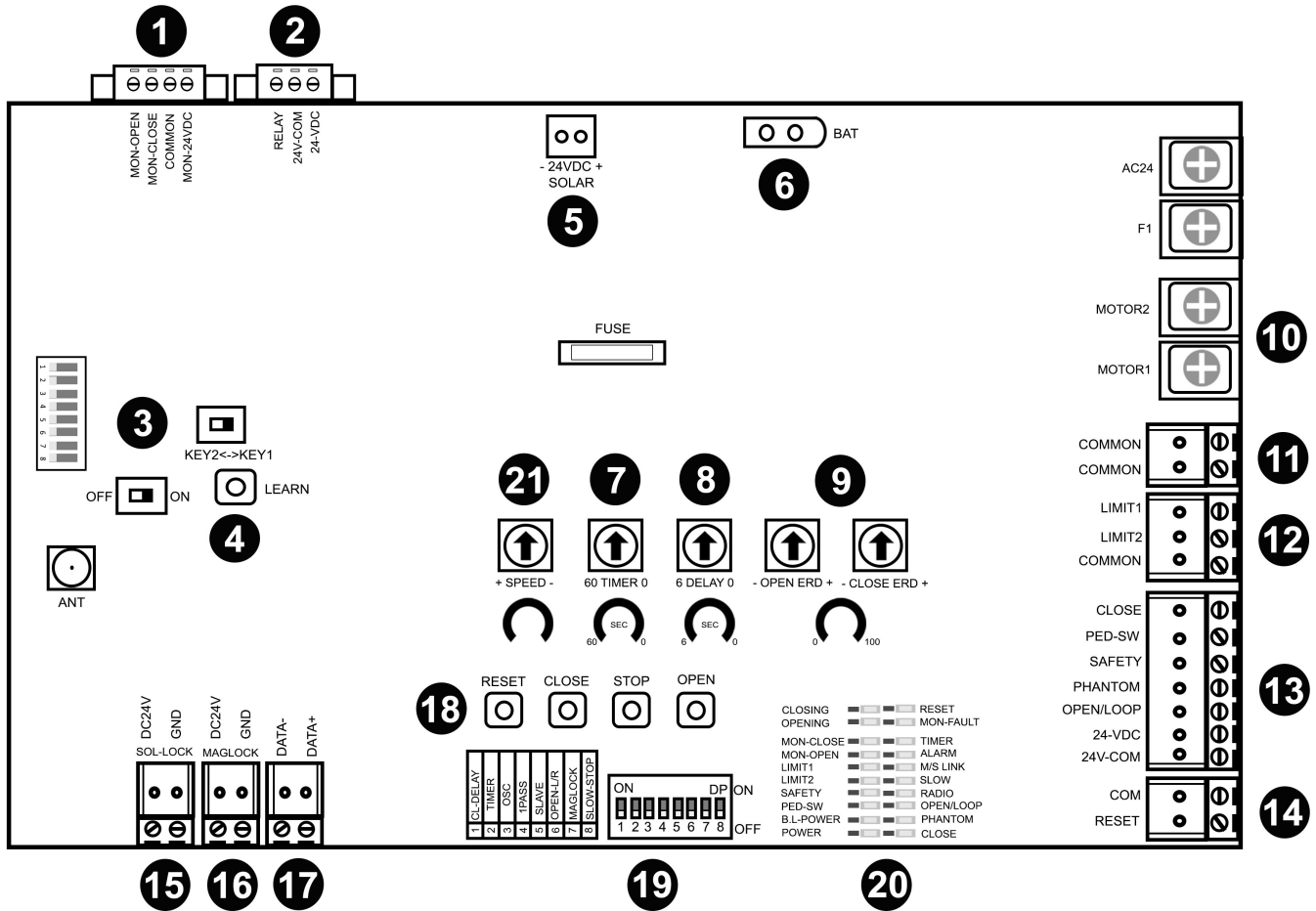

1. Photocell Sensor Input
2. Wired Keypad/Access Control Input
3. Remote Control Dip Switch Settings
4. Remote Control Learn (Study) Setup
5. Solar Panel Wire Input
6. Backup Battery Wire Input
7. Auto Close Timer Knob
8. Delay Timer Knob
9. Open and Close ERD Knob
10. Motor Input
11. Common Inputs
12. Open/Close Limit Inputs
13. Loop Detector Inputs
14. Common Global Input
15. Electric/Solenoid Lock Input
16. Maglock Input
17. Master/Slave Dual Gate Inputs
18. Open/Close/Stop/Reset Buttons
19. Dip Switches
20. LED Status Lights
21. Speed Knob

Remote Controls

By default, the remote controls are already connected to the gate operator. You do not need to do any of the following steps unless you are adding more remote controls.

This gate operator can add up to 50 different remote controls. To add more than 50 remote controls, add a receiver, which can add up to 100 additional remote controls. Calimet remote controls use 418 MHz frequency with a 300' max distance.

There are two ways to connect your remote control: Learn & Dip Switch.

Learn

Connect using Learn On your gate operator circuit board, look for the learn button. Press and hold the button on the remote control. Press and hold the learn button until the flashing light turns solid, about 2 seconds. Then release both buttons immediately. Done, the remote is now connected to the gate opener.

Remove all existing remote controls Press the LEARN button on the gate operator circuit board and hold for 8 seconds. Done. All remote controls are now removed.

Transfer remote control data to a new circuit board If you are replacing your gate opener circuit board with a new circuit board, you can pull the USB flash drive near the learn button, and place it into the new circuit board. All existing remote controls in the previous circuit board will automatically connect to the new circuit board, without needing to pair all of the remote controls again one by one.

Dip Switch

Only the CM9-509 red remote controls can be installed using the dip switch method.

- A. On your circuit board find the 1-8 Dip Switches, turn the nearby OFF/ON switch to ON.
- B. Unscrew the back of the remote control to gain access to the control board. You should see 1-8 dip switches. Each switch has 3 positions: up, middle, bottom. Flip these 1-8 switches to any random position you'd like, see Figure A.
- C. On the gate opener control board, set the same 1-8 dip switch combination on the as you did on the remote.
- D. Finished.

Figure A



Exit Loops

An exit loop is a device that opens the gate automatically when a car approaches the gate.

A reverse loop is a loop that reverses the direction of a closing gate if a car drives over it. It will also hold a gate open if a vehicle stops over the loop. If the gate is fully closed and a vehicle drives over it, the gate will not open. A phantom loop is a reverse loop located inside the property.

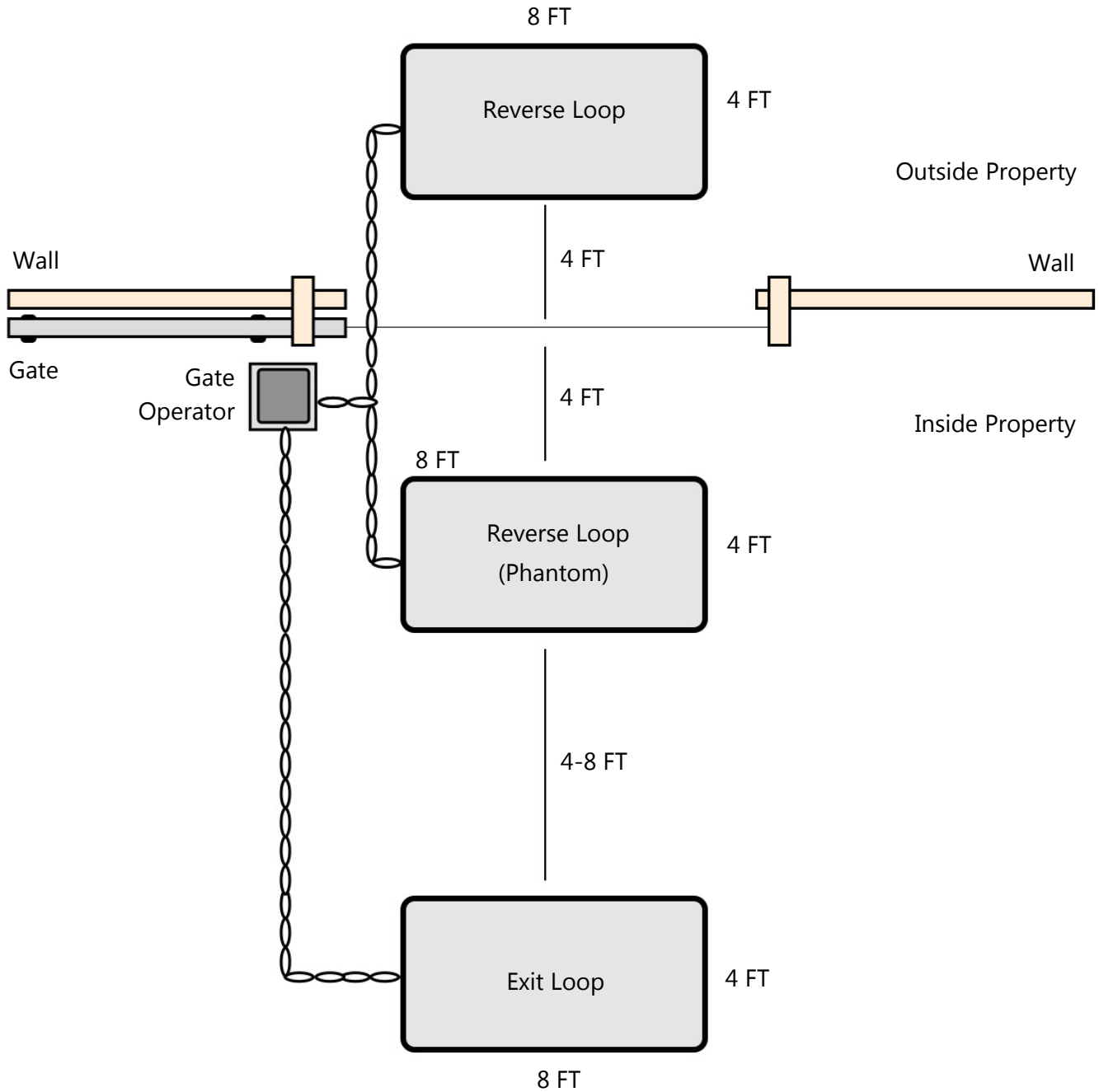

Exit Loops

Loop wires are installed 1.5" underground by cutting the concrete with a circular saw. The typical size loop is 8x4'. Common loop wires are size 16 or 18 AWG stranded copper XLPE (cross-linked polyethylene) electrical wire. 3 layers of turns are required for a typical 4x8' loop. For different size loops, use 4 turns for 10-20ft in perimeter, 3 turns for 20-32ft in perimeter, and 2 turns for 32-98ft in perimeter. The wire ends must be twisted back into the gate operator with a minimum of 6 twists per foot. The twisted ends must be placed inside a PVC conduit. Use caulk or sealant to close the ground once finished.

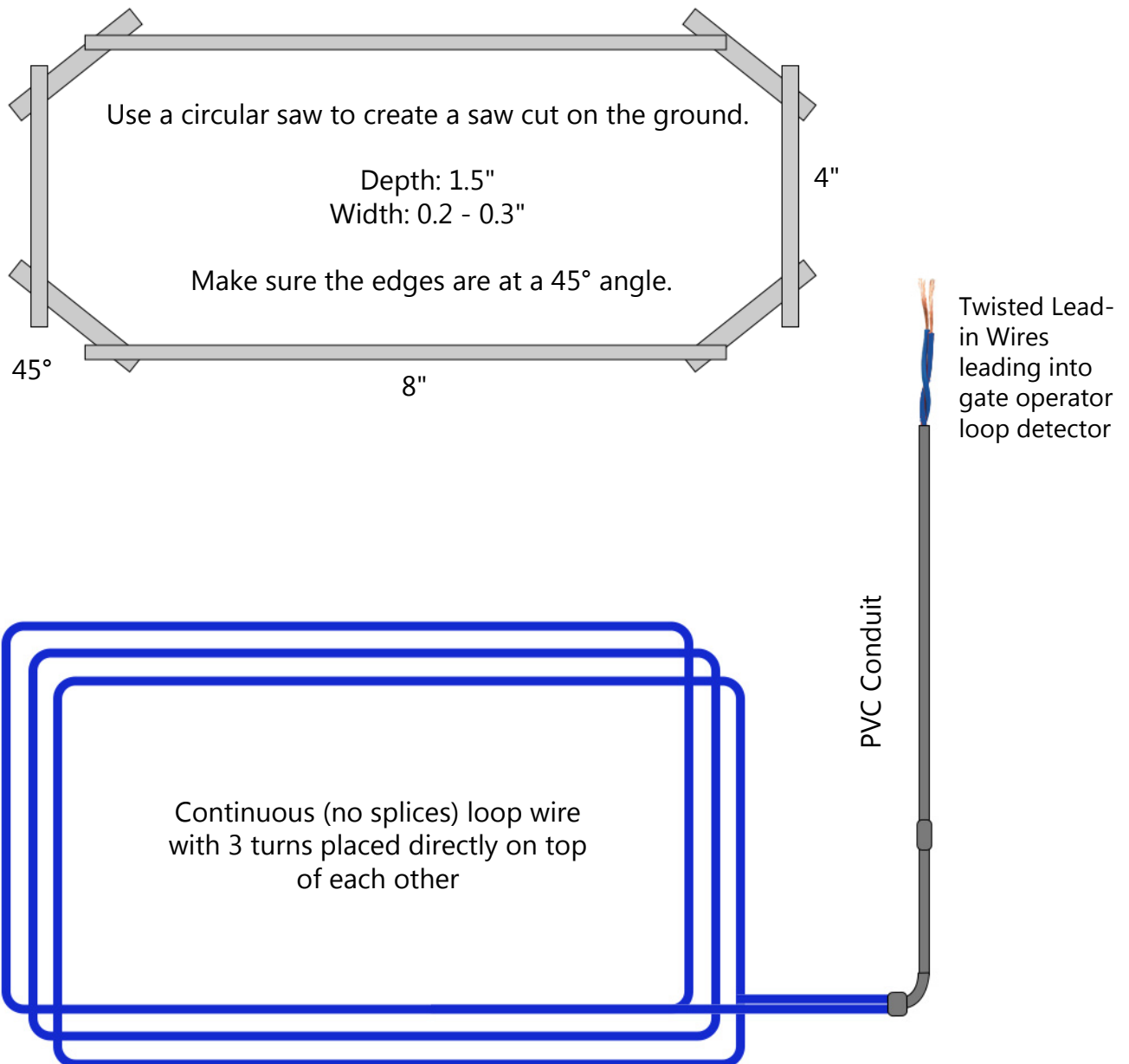

Exit Loops

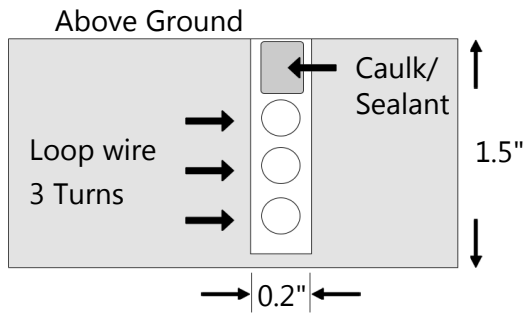

Loop Size (Sq ft)	Number of Turns
6' to 12'	6
13' to 20'	5
21' to 60'	4
61' to 240'	3
241'+	2

If you purchased a Calimet Loop Detector Harness, see the wiring diagram below to connect the loop detector to the gate operator circuit board.

For other brand exit loops or exit wands, use the Open/Loop input, and the 24-VDC and 24V-COM if using the gate operator to power the device.

For reverse loops located on the inside of the gate, use the PHANTOM input. For reverse loops located on the outside of the gate, use the SAFETY input.

The exit loop inputs are located on the bottom right of the gate operator circuit board.

Loop to Gate Operator Wiring Diagram

- Reverse → SAFETY
- Phantom → PHANTOM
- Exit → OPEN/LOOP
- Ground → 24V-COM
- 12VDC/24VAC → 24V-VDC

Loop lead-in wires connect directly to the loop detector harness, and not the gate operator circuit board.

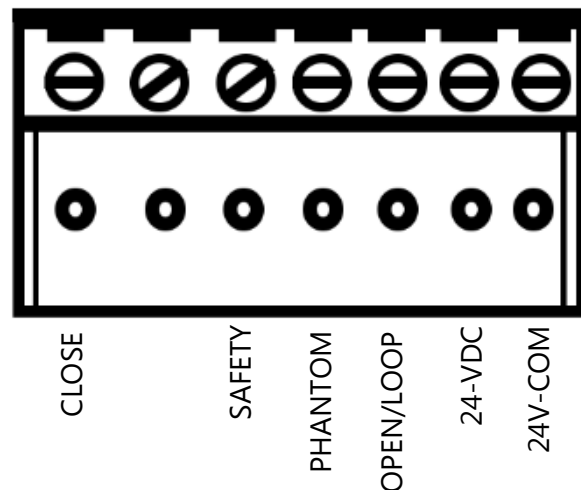

Accessory Wiring

Most accessories can be wired into the relay input.

Use OPEN/LOOP for Normal Open (N/O). Use Relay for Relay.

Use the CLOSE Input for Normal Close (N/C).

If using the gate operator to power the accessory, use 24-VDC and the 24V-COM input.

Figure A: Exit Loop Terminals - Located on the right side of the circuit board

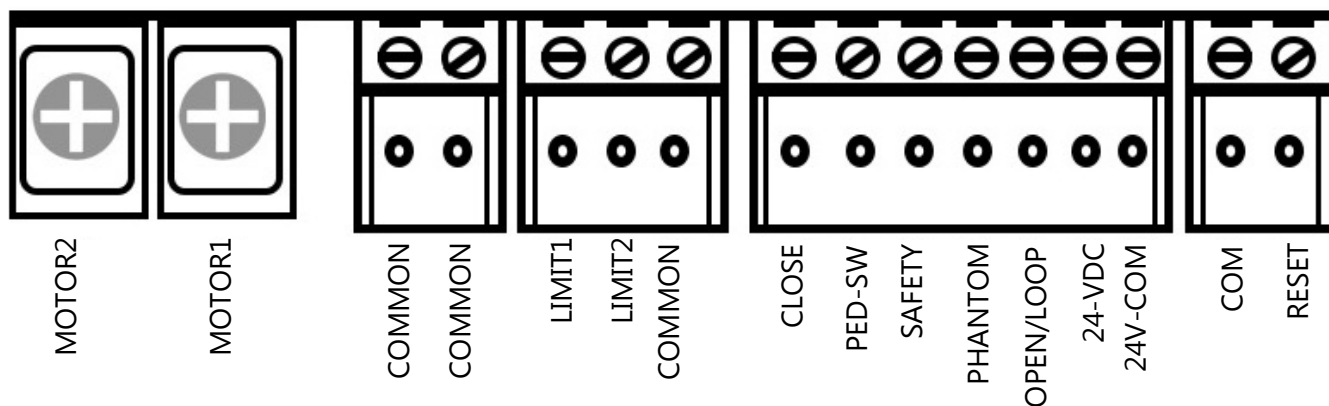

Commonly used for:

- Exit Loops / Reverse Loops
- Electric Locks
- Fire Access Box

Figure B: Relay Terminals - Located on the outside of the circuit board compartment, top left.

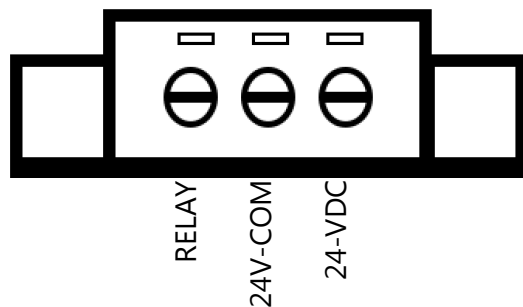

Commonly used for:

- Intercoms/Access Controllers
- Keypads

Figure C: Monitored Terminals - Located on the outside of the circuit board compartment, top left.

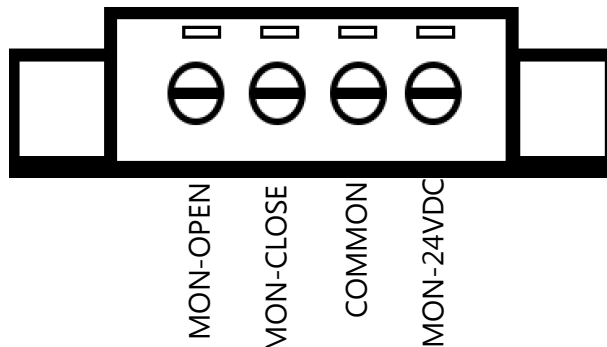

Commonly used for:

- Photocell Sensors
- Safety Edges

Accessory Wiring

Solenoid / Electric Lock

Ver 3.1 Circuit Board: Use the SOL-LOCK Input.

Ver 3.0 and below Circuit Boards: Use the Motor2 and Motor1 terminal.

MagLock

Ver 3.1 Circuit Board: Use the MAGLOCK input and turn dip switch #7 (labeled "MAGLOCK") to ON.

Use the Relay, Close (N.C), or Open/Loop (N.O.) inputs on the circuit board as necessary.

Push To Exit Button

Normal Open (N/O) - OPEN/LOOP

Normal Close (N/C) - CLOSE

If using the gate operator to power the accessory, use 24-VDC and the 24V-COM input.

Receiver

Relay/Normal Open - Relay

Common - 24V-COM

12-24V DC - 24-VDC

Photocell Sensor (Non-Calimet Brand)

Monitored CLOSE - MON-CLOSE

Monitored OPEN - MON-OPEN

Common - 24V-COM

12-24VDC - 24-VDC

For Calimet brand photocell sensors, see page "Step 6: Installing the Photocell Sensor".

Accessory Wiring

Fire Access Box

Use 14-20 gauge awg wire (not included) and splice (join) with the white and black wires.

Common (White wire) - 24V-COM

N/O (Black wire) - OPEN/LOOP

Safety Edge / Edge Sensor

The Calimet CM9-934 Safety Edge is wireless and requires no wiring.

For other brand safety edges, use the MON-CLOSE or MON-OPEN input depending on if it's monitoring the open or close cycle. Use COMMON and MON-24VDC if the safety edge requires electricity.

Keypad

For the Calimet CM9-535 Wireless keypad, follow the separate keypad instruction manual for installation details.

For wired and non-Calimet brand keypads, use a 20 gauge stranded electrical wire and connect using the following:

Normal Open/Relay - Relay

Common - 24V-COM

12-24VDC - 24-VDC

Access Controllers/Intercoms

Use a 20 gauge stranded electrical wire and connect using the following:

Normal Open/Relay - Relay

Common - 24V-COM

12-24VDC - 24-VDC

If the intercom/access controller requires a dedicated Normal Open/Normal Close input, use the OPEN/LOOP input on the bottom right of the circuit board for Normal Open, and the CLOSE input for Normal Close. The 24-VDC and the 24V-COM can supply electricity to the intercom/access controller.

Accessories

Battery

24V Batteries are added to the battery compartment at the bottom of the gate operator. There is a separate battery circuit board that connects to the BAT input on the main gate operator circuit board.

Batteries degrade over time depending on usage. Battery performance may decrease in extremely cold temperatures - performance can be increased by adding insulation to the inside of the gate operator battery compartment or adding a heater. The batteries should be replaced every 3-4 years.

Gate Operator Model Battery Compatibility

CM3-DCNB - Not included, will require a battery and battery circuit board upgrade

CM3-DCFB - Included, already installed

Solar Panel

Solar Panels can be wired into the 24VDC SOLAR input on the gate operator circuit board.

Multiple solar panels may be wired together to charge the battery faster. We recommend two 24VDC solar panels for optimal charging.

Place solar panel at a 45 degree angle, facing SOUTH. Note: optimal angle and orientation may vary based on your location and season.

Make sure the solar panel can receive direct sunlight. If a tree, or other forms of shade blocks the solar panel, move the solar panel to a different location.

Gate Operator Model Solar Compatibility

CM3-DCNB - not solar ready, will require a battery and battery circuit board upgrade

CM3-DCFP - solar ready

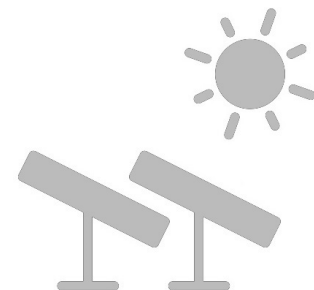
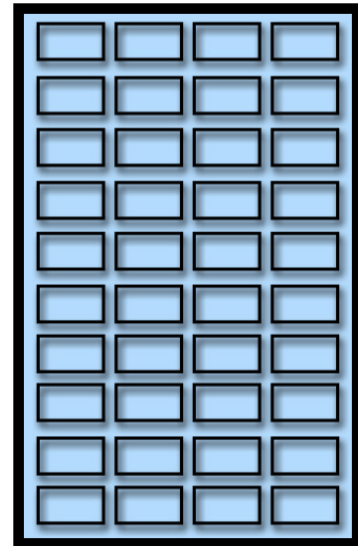

Circuit Board Light Status Chart

Name	Status/Light
CLOSE	ON when CLOSE input is activated
PED-SW	ON when STAND BY, OFF when the STOP input is activated or foot pedal is pressed down.
SAFETY	ON when Stand By, OFF when SAFETY LOOP input is activated
PHANTOM	ON when incoming signal is detected from a reverse loop (phantom)
OPEN/LOOP	ON when EXIT LOOP input is activated
LIMIT1	ON when limit nut has reached the limit 1 switch
LIMIT2	ON when limit nut has reached the limit 2 switch
RADIO	ON when the RADIO input is activated
RESET	ON when circuit board has been RESET
POWER	ON when the gate operator is on standby, blinks when motor is on
B.L-POWER	ON when back up battery is fully charged, blinks when low battery
M/S LINK	Blinks when master/slave communication is active
TIMER	Blinks when TIMER is counting down to close automatically
OPENING	ON when gate is in the open cycle
CLOSING	ON when gate is in the close cycle
MON-FAULT	ON when photo eye has malfunctioned
MON-OPEN	ON when photocell sensor is monitoring the open cycle
MON-CLOSE	ON when photocell sensor is monitoring the close cycle
SLOW	ON when the slow-stop dip switch (#8) is turned on

Alarm

The alarm will sound in these following situations:

- 1. Photocell Sensor Obstruction or Misalignment** -an object has crossed the photocell infrared beam when the gate was closing. If nothing interrupted the beam, the photocell sensor may be misaligned. Align photocell sensor with the reflector on the other side to fix the problem.
- 2. Impact Detection** - The gate operator has a built-in impact sensor called the ERD. If the gate collided with an object, the alarm will sound. If there was no collision, the ERD force may be set too low. Increase the force to fix the issue. Another possible issue is that the chain may be bent or not correctly aligned to the sprocket.
- 3. Low Battery** - Battery is low. Recharge using solar panel or AC electricity. DCFP models only.

Troubleshooting

Problem	Possible Causes	Solution
Gate operator has no power	<ul style="list-style-type: none"> A. Electrical Outage B. Circuit Breaker Tripped C. If using solar panel only (no AC electrical power), battery level may be depleted D. If using solar panel only, battery may need to be replaced E. Conduit and/or power cables are damaged or have corrosion F. Fuse Blown due to electrical overload or faulty wiring G. Circuit Board Malfunction 	<ul style="list-style-type: none"> A. Wait until the power comes back on B. Reset Circuit Breaker C. Recharge the battery by using solar or AC electricity. D. Replace battery. E. Replace wiring. F. Replace fuse G. Replace circuit board.
Gate operator does not open	<ul style="list-style-type: none"> A. No Power B. Remote control has no battery C. Gate is damaged, misaligned, or obstructed D. Foot pedal is set to manual release E. Circuit board Malfunction 	<ul style="list-style-type: none"> A. Check to make sure electricity is working. If using solar only, give the gate operator 2-3 days to recharge the battery. B. Replace battery. C. Check for any damages, obstruction, or misalignment on the gate. D. Step on the foot pedal and move it to the upper-left. E. Replace circuit board
Gate operator can open but does not close	<ul style="list-style-type: none"> A. Photocell Sensor is not aligned B. Open direction is reversed 	<ul style="list-style-type: none"> A. Align photocell sensor with the reflector on the other side. B. Dip Switch #6: OPEN-L/R on the circuit board - set to the opposite position.

Troubleshooting

Problem	Possible Causes	Solution
Gate does not close all the way	A. Limit positions not adjusted properly	A. Readjust limit position by turning the limit cams
Gate operator opens on its own	A. Radio frequency interference from another nearby gate operator or garage door operator B. Loop detector may be too sensitive to environmental vibrations	A. Erase all remote controls on the system by holding the study button on the circuit board for 8 seconds. Manually re-add the remote controls back in by pressing the remote control and the study button until the flashing light turns solid (about 2 seconds) B. Downgrade sensitivity on the loop detector
Gate reverses when traveling	A. Not enough force B. Low Battery	A. Increase force by turning the third (open) and fourth (close) blue knob labeled "ERD" slightly clockwise. B. Charge battery using solar panel or 110VAC electricity

Maintenance

Description	Task	Check every
Gate	Inspect swivel arm, hinges, posts, and other parts for wear, damage or misalignment. Lubricate if necessary. There should be no squeaking.	1 month
Photocell Sensor check	Place your hand over the photocell sensor infrared beam when the gate is closing. The gate must stop and reverse.	1 month
Safety Edge	If using safety edges, check the battery. Replace batteries with 3V CR2450 coin batteries (2 quantities) every 3 years.	1 month
Warning Signs	Two signs should be installed. One is visible to people on the outside of the gate, and one is visible to people on the inside of the gate.	1 month
Emergency Release	Turn off power and step down on the foot pedal to move it to the right. Manually push the gate to ensure that it can fully open and close.	2 months
Free Movement Check	Step on foot pedal and move it to the right. Manually push the gate with your hands. Gate should move freely and easily with little to no resistance.	2 months
Force	Gate should reverse when it comes in contact with object. Test both open and close ERD force.	6 months
Accessories	Check all gate operator accessories including remotes, loop detectors, keypad, etc. to make sure they are all operating properly.	1 year
Electrical	Check wiring connections to make sure none are loose or damaged	1 year
Chassis Sleeve Anchors	Check to make sure the anchors are not loose or damaged.	1 year
Battery	Replace battery.	4 years

MANUFACTURER'S LIMITED WARRANTY

The warrantor, CALIMET CO., INC, warrants the gate operator(s) for a period of three (3) years in commercial installations and for a period of five (5) years in residential installation to be free from defects in motor, gearbox, circuitry, and workmanship. This warranty is limited to two (2) of any combination of repairs or replacement of parts. This warranty applies from the date of purchase to the original owner. Warrantor will repair or replace (at warrantor's sole discretion) any part which it finds to require service, excepting that, this limited warranty does not cover the following: corrosion and, damage or failures resulting from environmental conditions, vandalism, water, lack of proper maintenance, accident, theft, fire, normal wear and tear, misuse, alteration, tampering, improper repair, installation of non-CALIMET approved parts, accessories, or components. This device must be sent to the warrantor at the consumer's expense to:

CALIMET CO., INC.
9949 HAYWARD WAY
SOUTHE EL MONTE, CA 91733

The warrantor will return the repaired or replaced unit to the customer at the consumer's expense. This limited warranty does not cover labor fees for reinstalling a repaired or replaced unit or parts. These warranties are in lieu of all other warranties either expressed or implied, and CALIMET CO., INC shall not be liable for consequential damage. All implied warranties of merchantability and or fitness for a particular purpose are hereby disclaimed and excluded. This limitation is not valid in jurisdictions which do not allow limitation of incidental or consequential damages or limitation of warranty periods. Please complete the registration card and send it by mail within 30 days of purchasing from CALIMET CO., INC. or your INSTALLER. If not registered only a one year warranty on all parts will be provided.

The warranty card must be mailed to the address listed on the card. Alternatively, the warranty can be completed online at <https://calimetco.com/gate-operator-warranty-registration>

Notes

Date Installed: _____

Model Number: _____

Serial Number: _____

Installer Name: _____

Installer Company: _____

Installer Address: _____

Installer Contact: _____

NOTES

CALIMET

9949 Hayward Way South El Monte, CA 91733

Tel: 626-452-9009 Fax: 626-452-9010

Email: info@calimetco.com

www.calimetco.com

