

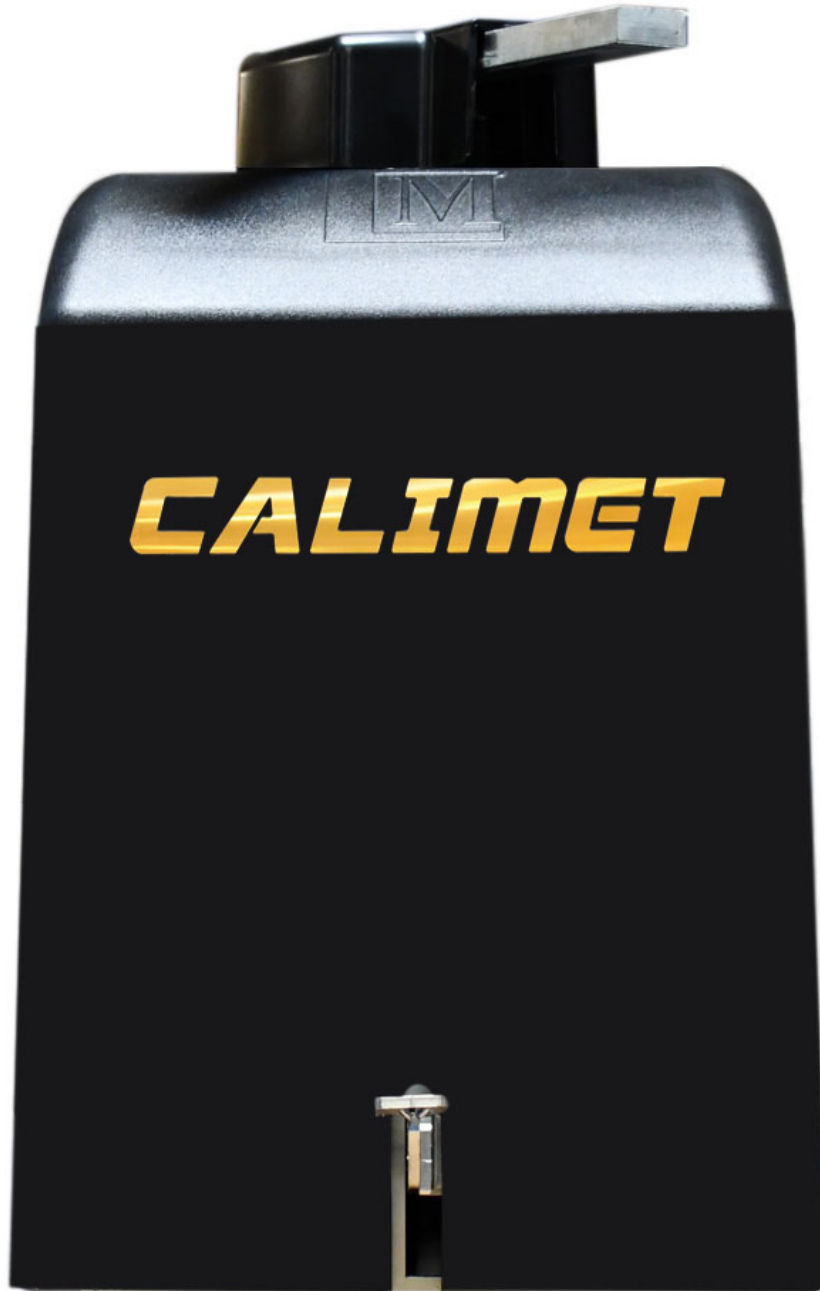

Instruction Manual

# CM7-ACFP

Swing Gate Operator



[www.calimetco.com](http://www.calimetco.com)

9949 Hayward Way South El Monte, CA, 91733 Tel: (626) 452-9009

## PRODUCT SPECS

Voltage Input: 110V

Maximum Output Current: 15 amp, Fuse: AC 110V 15 amp

Remote Control Distance: > 150 Feet (50 meters)

Maximum Gate Weight: 2500 lbs

Maximum Gate Length: 25 Feet

## LANGUAGES

To download this user manual in a different language, visit [calimetco.com/manuals](http://calimetco.com/manuals)

Para descargar este manual de usuario en otro idioma, visite [calimetco.com/manuals](http://calimetco.com/manuals)

下载其他语言版本用户手册 请访问 [calimetco.com/manuals](http://calimetco.com/manuals)

## WARNING

To reduce the risk of INJURY or DEATH:

- Never let children operate the gate or play around the gate. Keep the remote control away from children.
- Always keep people and objects away from the gate. Cars, people, and other objects should never enter when the gate is closing.
- Verify this operator is proper for the type and size of gate.
- Make sure the gate has been properly installed and slides freely in both directions. Repair or replace all worn or damaged gate hardware prior to installation.
- Test gate operator monthly. The gate must reverse when it comes in contact with a solid object, or stop when an object activates the non-contact sensors. After adjusting the force or travel limit, re-test the gate operator. Failure to maintain the gate operator properly can increase the risk of injury or death.
- Use the emergency release only when the gate is not moving.
- Keep the gate properly maintained. Read the owner's manual on how to maintain your gate. Have a certified service technician make repairs or install gate operator hardware.
- The gate entrance should be used for vehicles only. Pedestrians should use a separate entrance.
- Keep these instructions.

## Step 1: Installing the Base

The base, also known as a pad is a raised platform. We recommend using a concrete base.

1. Lay out position of 6 wedge anchors by measuring clearance between anchors and inside edge of gate. Figure 1
2. Install underground conduits in area for conduits. Figure 2



Wedge Anchor  
1/2" x 3 1/2"

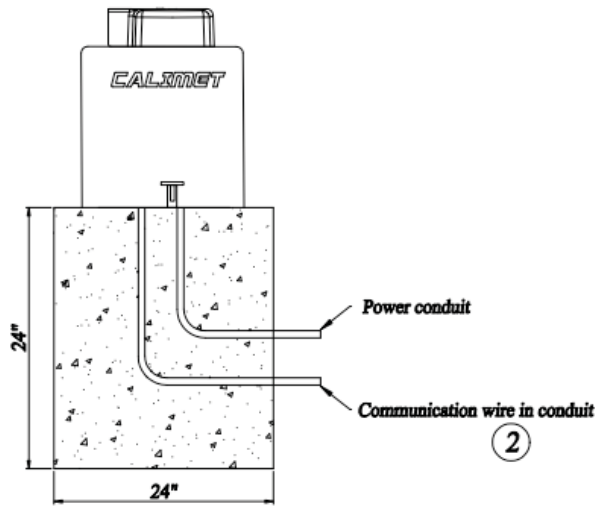
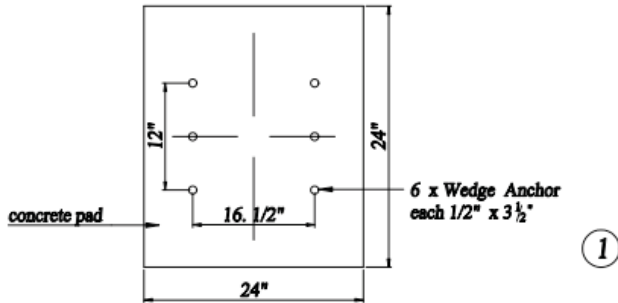

Figure 1

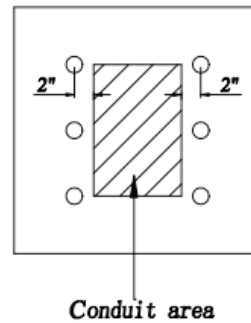

Figure 2

### Size of concrete base

A minimum of 2" on each side of the operator is recommended.



### **CAUTION**

Contact local underground utility locating companies before digging more than 12 inches deep to avoid damaging underground power, gas, or other utility lines.

## Step 2: Door arm installation

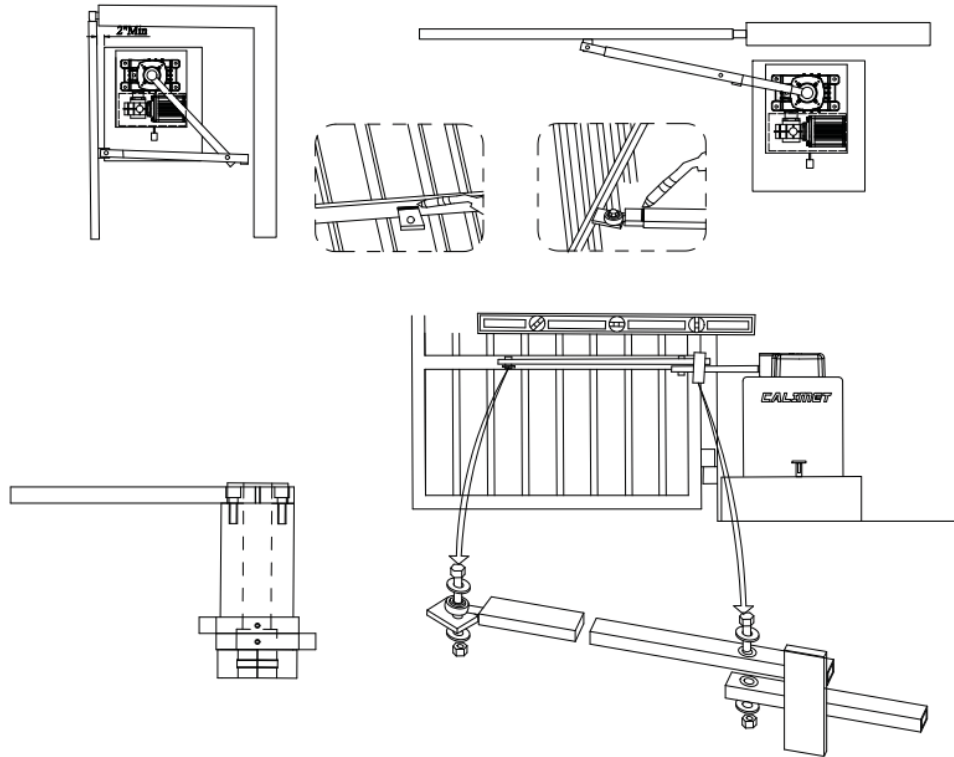

Figure 3

After you're satisfied with testing the arm in the full open and closed positions, weld gate bracket and arm.

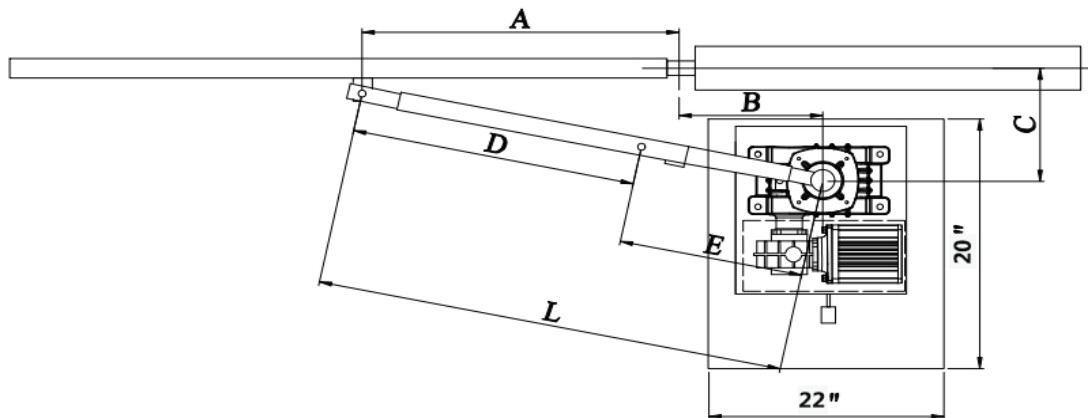

Figure 4

- A. Should be at least 1/4 the gate length. NOTE: Uphill or heavy gates should be at least 1/3 gate length.
- B. 14" minimum for open gate clearance (2" thick gate)
- C. 27" distance
- D&E. Arm should be 90° from gate when open and in the straight "locked".  $D=L*0.6$ ,  $E=L*0.4$

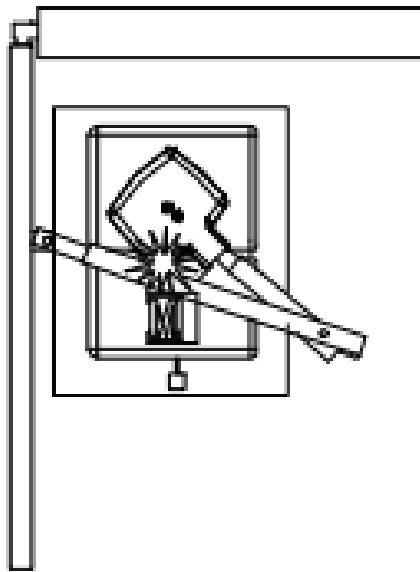

Figure 5

A. DO NOT allow the arm to touch the gate operator's hood when the gate is in the open position. Too much stress is put on the arm in this position during gate operation.

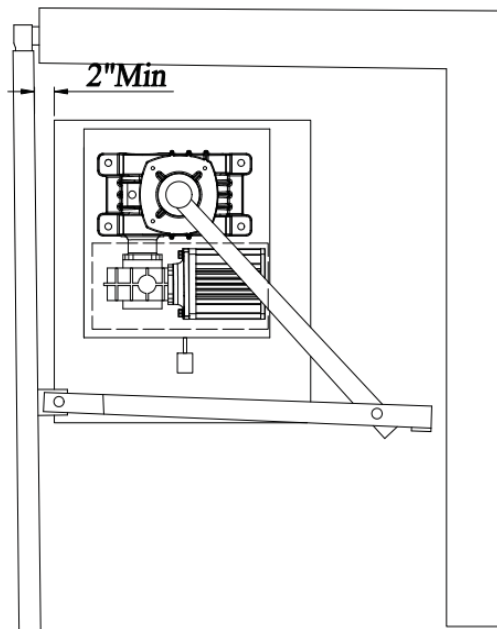

Figure 6

- A. Preferred arm position is 90° from the open gate.
- B. NOTE: If dimension between open gate and wall is 20" to 32" then compact installation is necessary. (See Figure 7)
- C. Distance between door and machine: 2" min

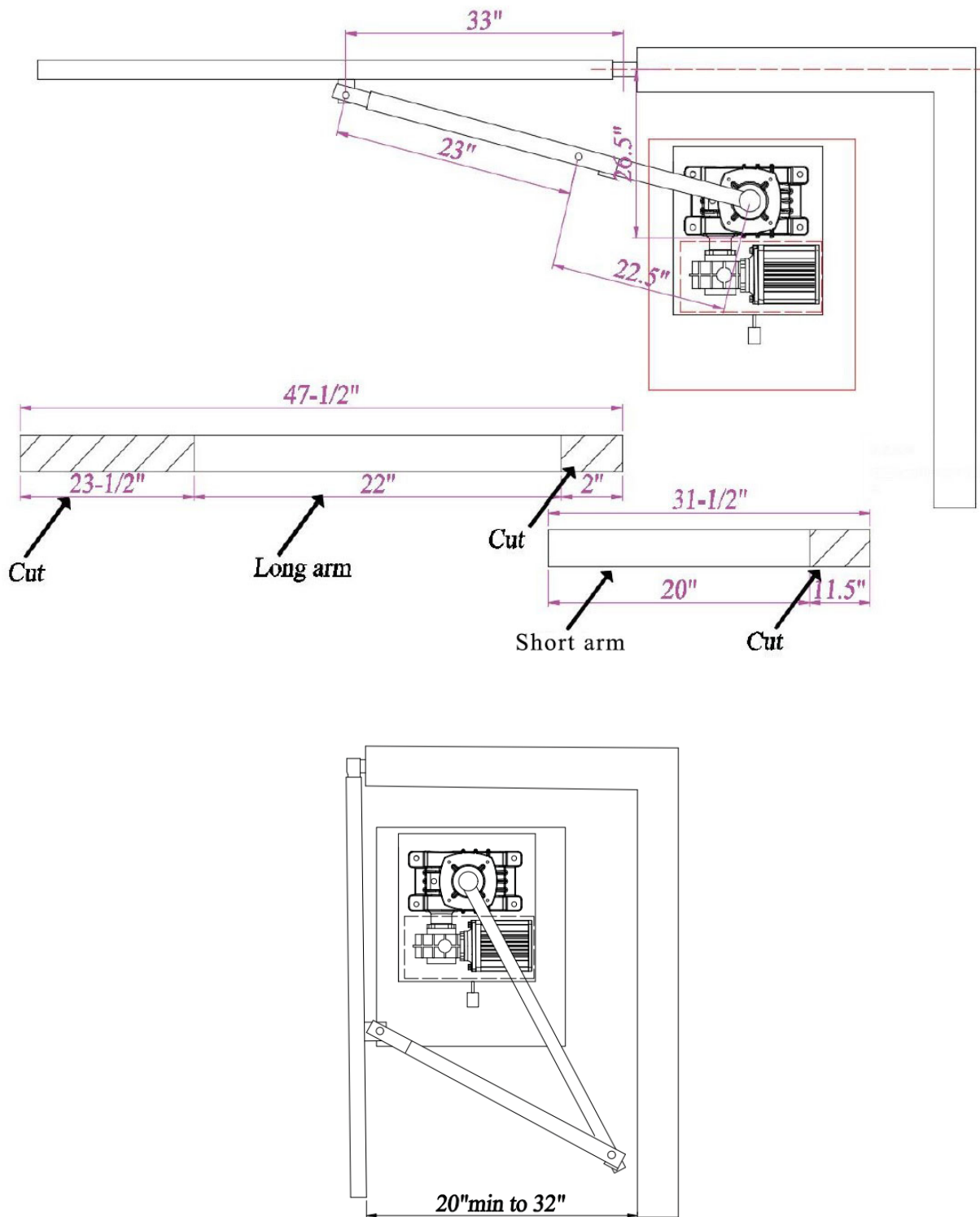

Figure 7

Support bar should be installed at the gate bracket height across the entire gate to keep the gate pickets from bending.

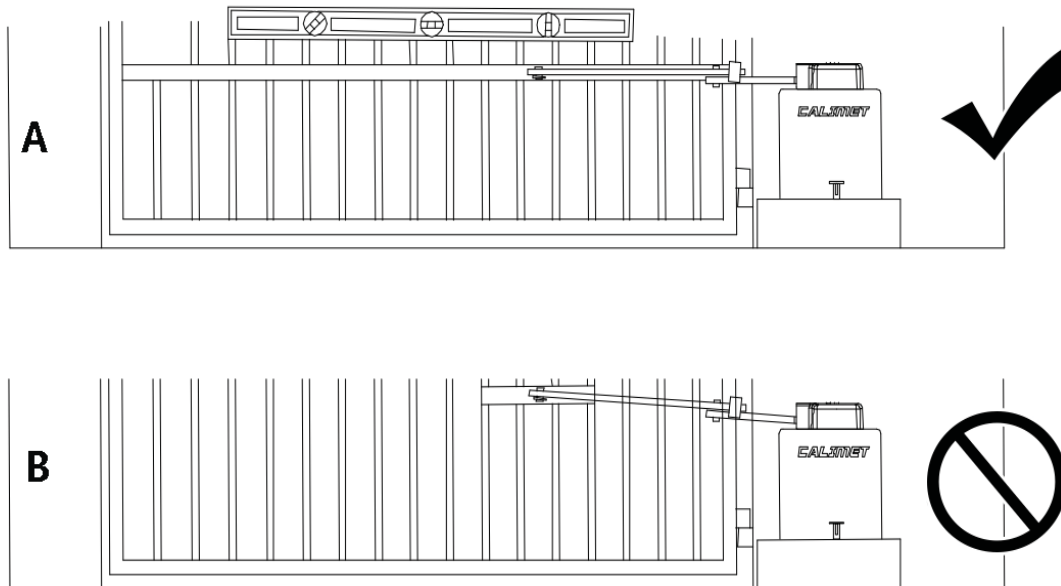

Figure 8

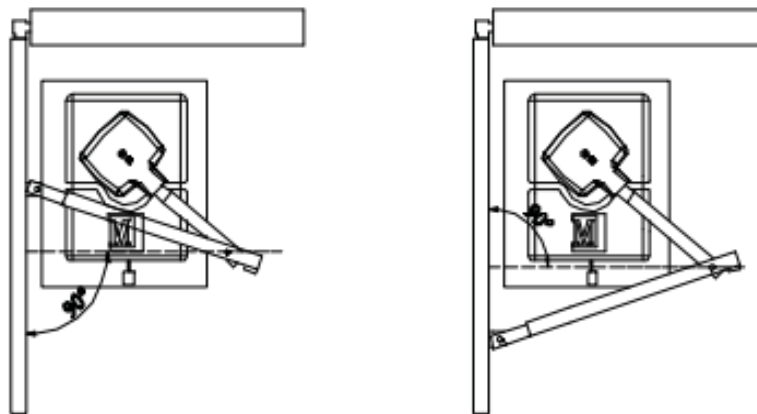

Figure 9

### Step 3: Connecting the Power

1. MUST use UL approved power wires, power wires MUST have minimum capacity for 15 amp current.
2. All operators MUST be properly grounded in order to prevent an electrical charge. Must use a dedicated circuit for power supply.
3. When the power is connected, turn operator power switch to ON position.

## Step 4: Open Position

### Open Direction

Choose whether your gate opens left or right.

Dip Switch #6 (Figure 10) on the bottom of the gate operator circuit board controls the open direction.

On = opens right, Off = opens left

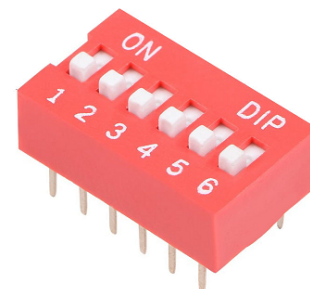

Figure 10

## Step 5: Installing the Photo Eye

1. Plug the photo eye cable to the back of the gate opener, behind the circuit board, Figure 11
2. Press the reset button on the gate operator control board.
3. Mount the photo eye on the stationary part of your gate or a post next to your gate, about 21" from the ground.
4. Press the orange button on the photo eye to turn on the infrared beam.
5. Mount the reflector to the opposite side. Make sure the infrared beam hits inside the circle of the reflector. Figure 12
6. Press the orange button on the photo eye to turn off the infrared beam.

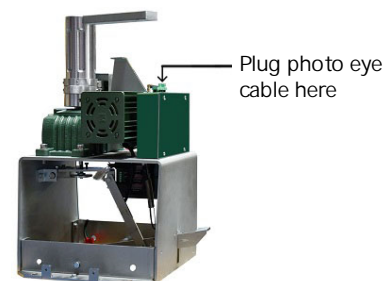

Figure 11

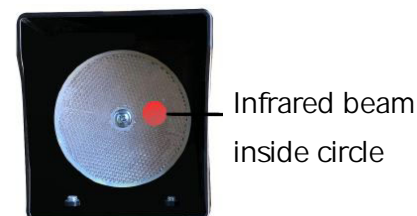
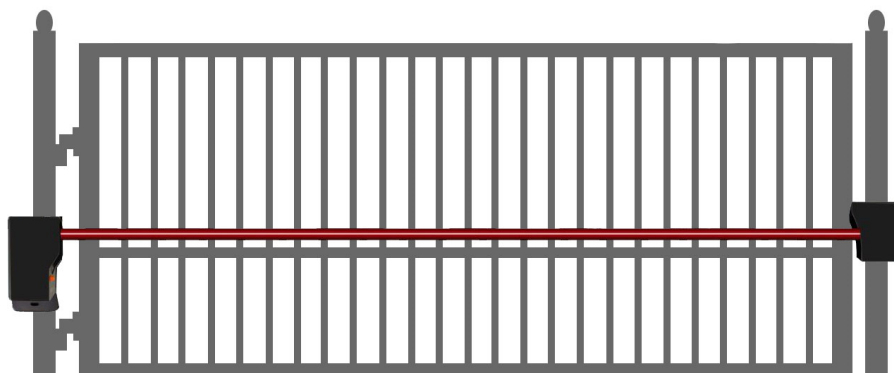

Figure 12



### **Youtube**

Youtube video with more details on how to install the photo eye: [https://youtu.be/F7NpB9W\\_OMY](https://youtu.be/F7NpB9W_OMY)



## Step 6: Gate Travel Limit

This controls the position of where the gate stops when it opens and closes.

1. Use a screwdriver to loosen the nails on the top and bottom limit cams
2. Turn left or right on both limit cams to adjust the position of where the gate opens and closes. Figure 9

TIP: Use the OPEN, CLOSE, STOP buttons on the gate operator circuit board for faster testing

3. Use the screwdriver and screw back in the limit cam nails

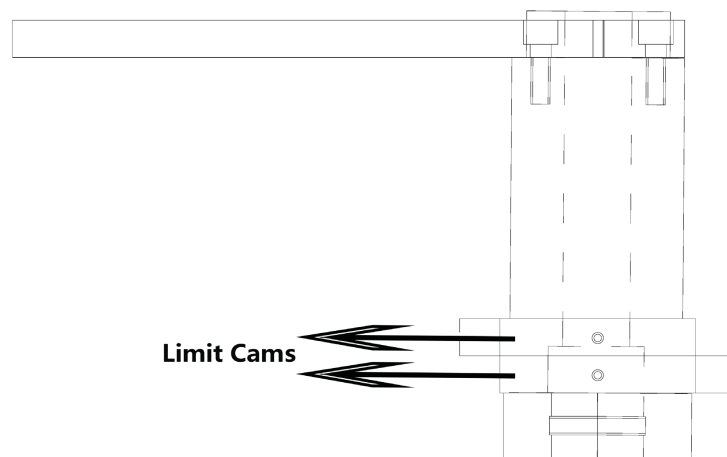

Figure 13

### Youtube

More detail on travel limit programming: [https://youtu.be/\\_DeVM5dgZPs](https://youtu.be/_DeVM5dgZPs)

**Finished!** You are now finished installing your gate operator.

## EMERGENCY RELEASE

The emergency release allows you to open the gate manually, such as in cases where there is a power outage and there is no electricity.

### Opening the gate

1. Disconnect power.
2. Push release pedal downward and move slightly to the right until it is locked in.
3. Hold and push gate to desired direction.

### Reset the Pedal

Reset the pedal only when the operator doesn't work while using the remote control.

1. Push the pedal downward from locked position and slightly move to the left.
2. Allow the pedal rise up to the reset position and release the pedal.

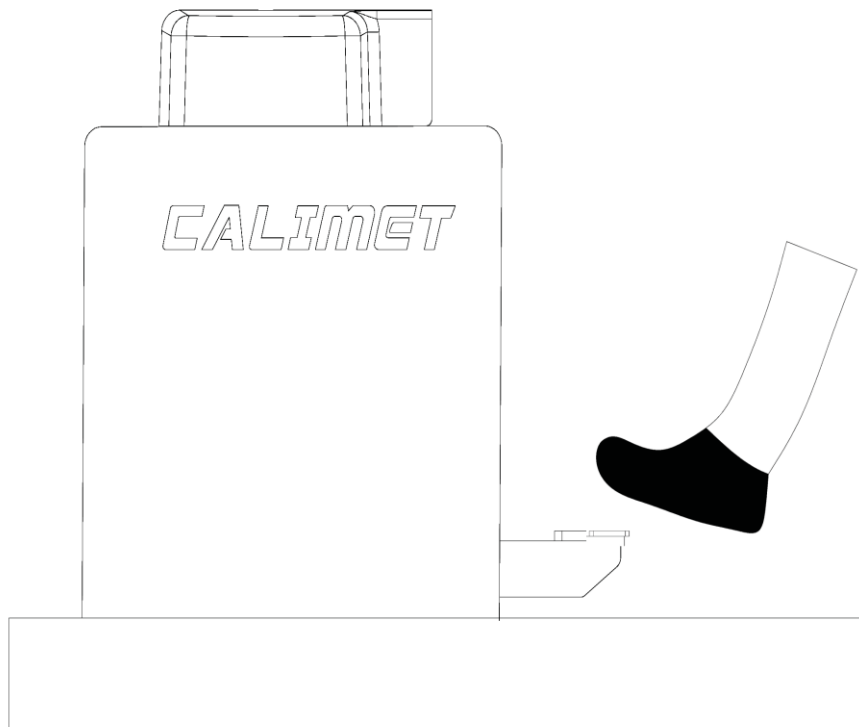

Figure 14

## Entrapment Protection

### Safety and Exit Loop

This is an optional step. If you wish to install a exit loop detector, see figure 15 for the position of the safety and exit loops.

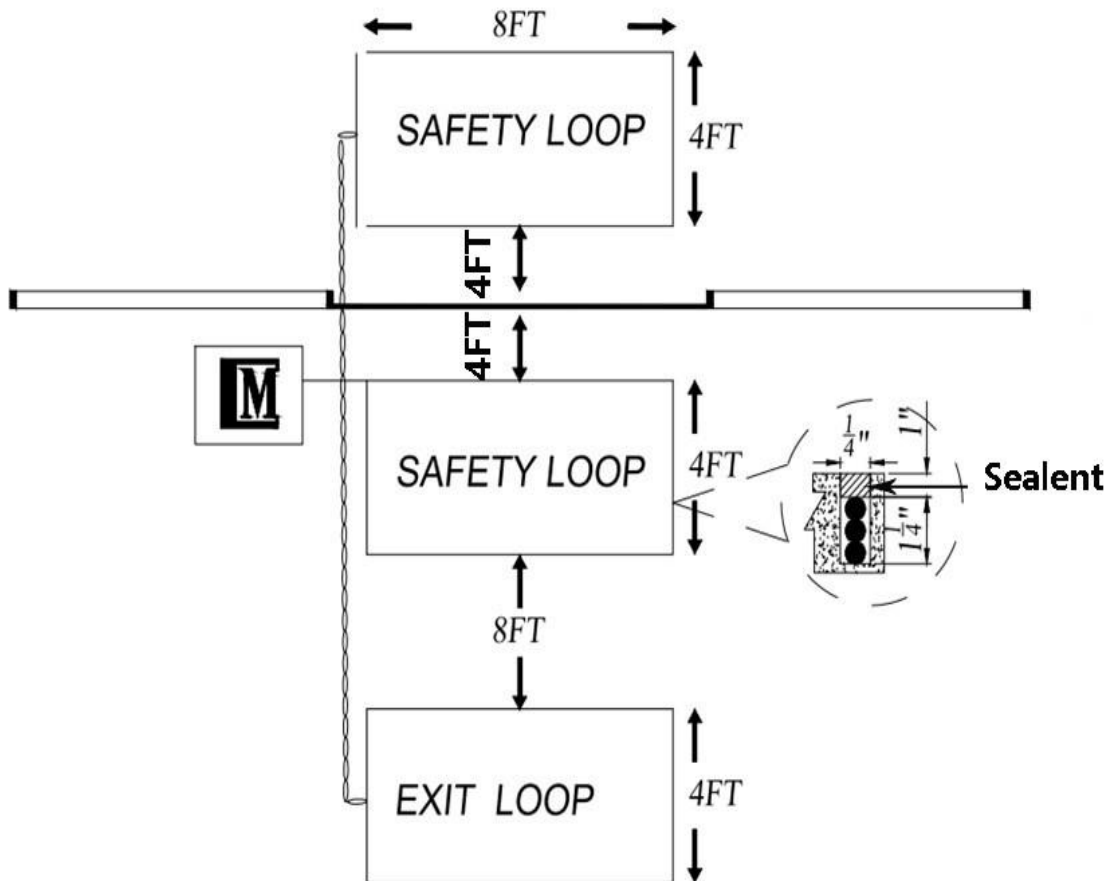

Figure 15



## Connecting Additional Remote Controls

By default, the remote controls are already connected to the gate operator. You do not need to do any of the following steps unless you are adding more remote controls.

There are two ways to connect your remote control: Study Mode & Numeric Mode.

### Study Mode

Study mode can fit up to 60 different remote controls.

Connect using Study Mode On your gate operator circuit board, look for the study key. Press and hold the button on the remote control. Press and hold the study key for 1.5-2 seconds. Done, the remote is now connected to the gate opener.

Removing existing remote controls Press the STUDY key on the gate operator circuit board and hold for 8 seconds. Done. All remote controls are now removed.

### Numeric Mode

A. On your circuit board, turn the SW9 key to the ON position.

B. Unscrew the back of the remote control to gain access to the control board. You should see 1-8 dip switches. Each switch has 3 positions: up, middle, bottom. Flip these 1-8 switches to any position you'd like.

C. On the gate opener control board, look for the same 1-8 dip switches, and set the same combination as you did on the remote.

D. Finished.

Note: On switch SW10, KEY 1 and KEY 2 are used for the 2-button model of remote controls. Note: if KEY 1 code was set with BUTTON ONE on remote control; KEY 1 will NOT work with BUTTON TWO on the remote control.

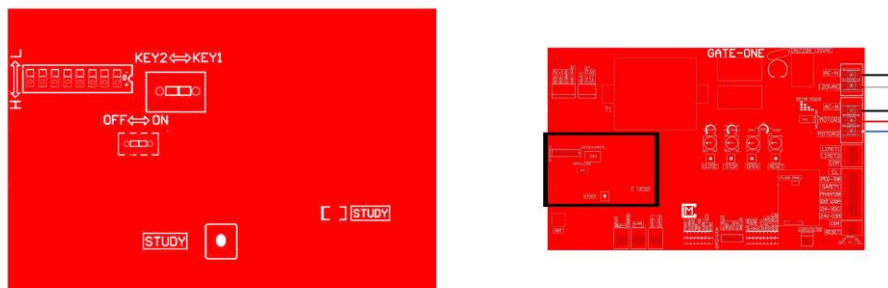

Figure 17

### Youtube

Youtube video that explains more on remote control programming:  
<https://youtu.be/QfT6O4apT18>

## DIP Switch Features

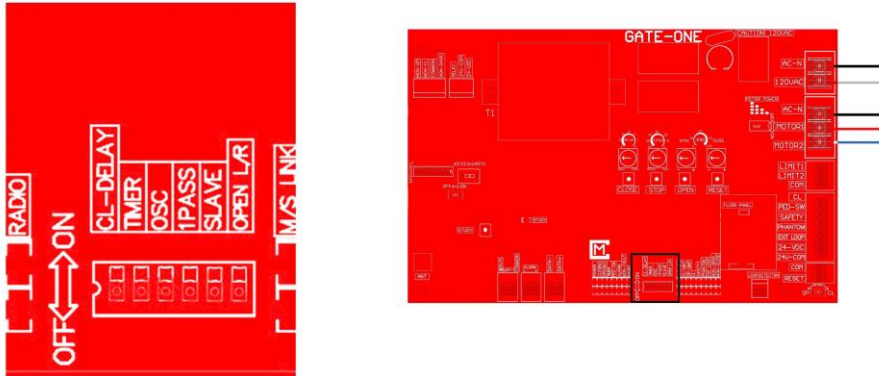

Figure 18 DIP switch

1. CL-DELAY: Gate Closing delay, switch to ON position, turn timer to 1- 6 seconds.
2. TIMER: 1-60 Timer: Auto activated to close gate upon set time ( 1~ 60 seconds).
3. OSC: Remote control priority. Allow remote control to direct gate movement whenever gate is moving in any direction. Use first signal to stop gate, use second signal to move gate to opposite direction.
4. 1 PASS: Anti-tailgating system. It corresponds to underground safety loop. After the vehicle has cleared safe loop outside of property, gate will start to close immediately without opening to limit, when ON is selected. If second vehicle across loop at this time, gate will stop. The second vehicle must get off the loop and then gate will continue to close completely.
5. SLAVE: Secondary operator activation
6. OPEB L/R: Choose gate open direction Left or Right.

## Use Infrared Control

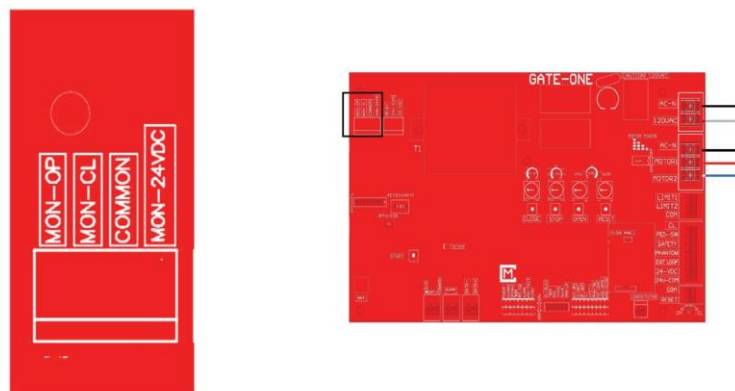

Figure 19

Follow infrared control instruction to connect power. Common wire is connected to Common pole, signal wire is connected to OPEN or CLOSE pole.

## External Receiver

External connectors are installed on the rear side of mainboard protector box.

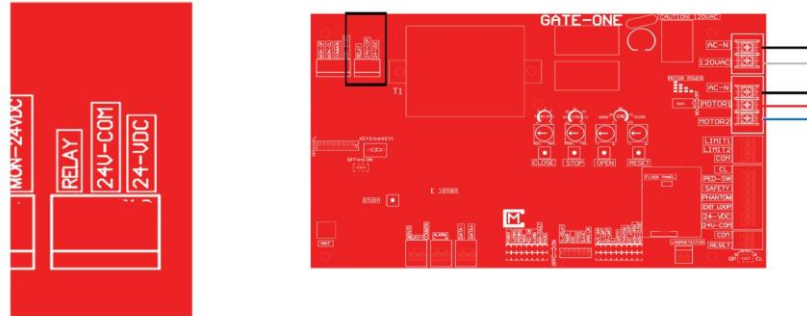

Figure 20

## Slave operator activation

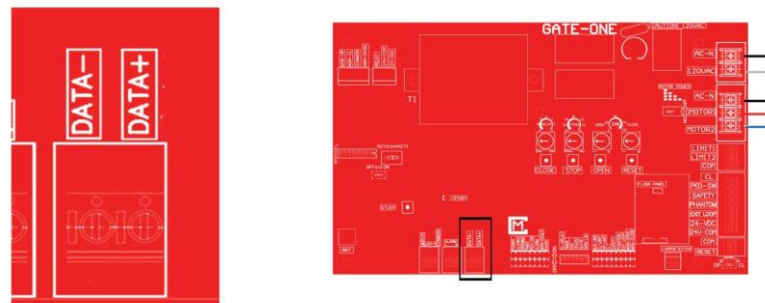

Figure 21

1. Set SLAVE switch on SLAVE CONTROL BOARD to ON position.
2. Use UL proved electric wire connect DATA- and DATA- from Master control board to Slave control Board, then connect DATA+ and DATA+ accordingly.
3. M/LINK light turns to solid bright.

## Sensitivity

The sensitivity has to do with the weight of the gate, and also other factors. A heavier gate will require less sensitivity, and a lighter gate will require more sensitivity.

If a gate is too sensitive, the gate may stop or reverse by itself. If it's not sensitive enough, it might not stop or reverse.

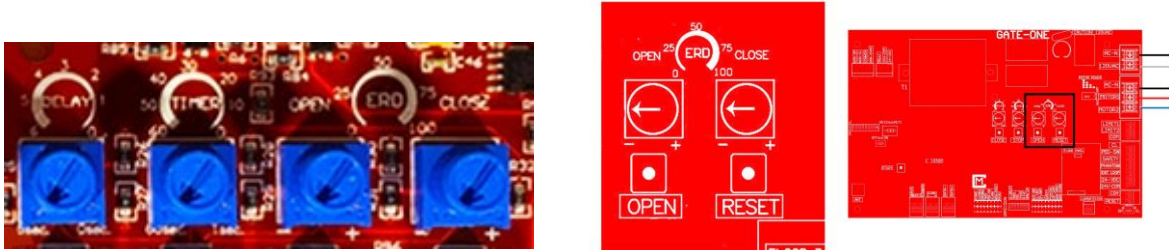

Figure 22

1. OPEN Sensitivity: Increase/decrease amount of force by turning knob clockwise/counter clockwise. This is the third blue knob in the circuit board. Figure 22, left.
2. CLOSE Sensitivity: Increase/decrease amount of force by turning knob clockwise/counter clockwise. This is the fourth blue knob on the circuit board. Figure 22, left.
3. Test device sensitivity every 6 months.

## Remote Control & Timer Delay Closing

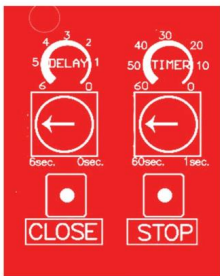

Figure 23

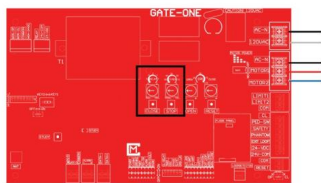

Figure 24

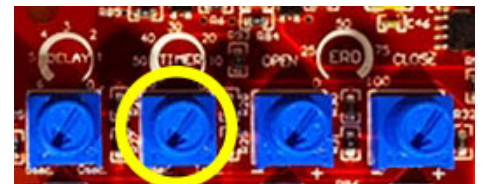

Figure 25

### A. Remote Control delay closing

1. Choose time delay to activate operator between 0-6 seconds by turning knob on DELAY

### Auto Close

This allows your gate to automatically close after opening it.

1. On your gate operator circuit board in the bottom, turn Dip Switch #2 to the ON position. Figure 24
2. On the gate operator circuit board, adjust the delay by turning the second blue knob from 0-60 seconds. Figure 25



# CALIMET

9949 Hayward Way South El Monte, CA 91733

Tel: 626-452-9009 Alternate: 626-482-3066 Fax: 626-452-9010

Email: [info@calimetco.com](mailto:info@calimetco.com)

[www.calimetco.com](http://www.calimetco.com)

