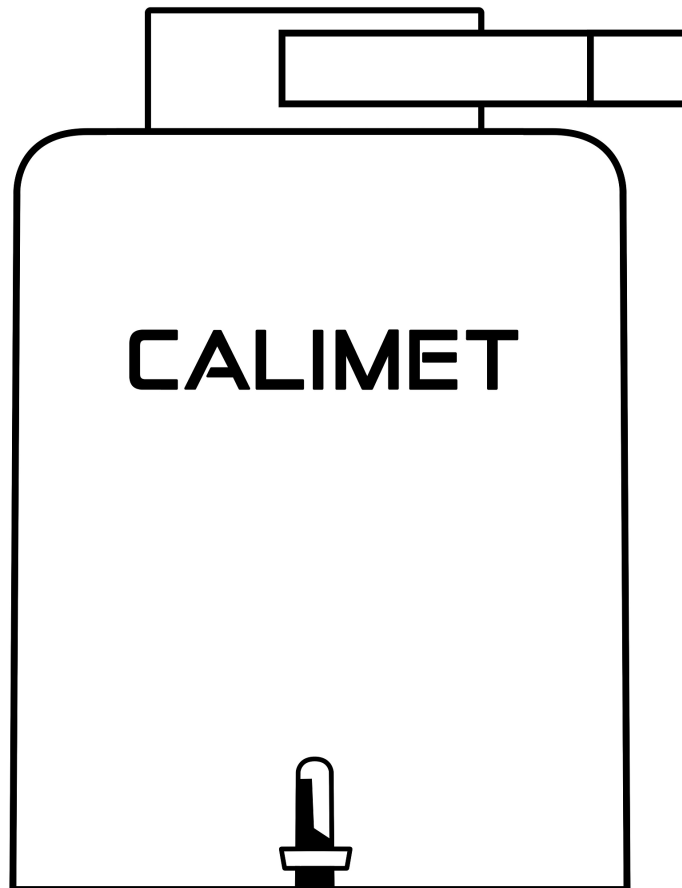


CALIMET

Access Control Systems

CM6

Swing Gate Operator



Installation and Owner's Manual

TABLE OF CONTENTS

OVERVIEW	Gate Operator Overview.....	2
	Safety.....	3
	Requirements for UL Compliant Installation.....	4-6
INSTALLATION	Before Installation.....	7
	Step 1: Standard Installation.....	8
	Step 2: Install a Concrete Pad.....	9
	Compact Installation.....	10
	Swivel Arm Positioning Tips.....	11
	Step 3: Weld the Door Arm.....	12
	Step 4: Connecting the Power.....	13
	Step 5: Open Direction.....	14
	Step 6: Install the Photocell Sensor.....	15-16
	Step 7: Adjust the Gate Travel Limits.....	17
	Step 8: Force Adjustment.....	18
	Step 9: Install Warning Signs.....	19
	After installation.....	20
FEATURES	Dual Gate Setup.....	21
	Emergency Release.....	22
	Dip Switch Features.....	23
	Circuit Board Layout.....	24-25
ACCESSORY WIRING	Remote Controls.....	26
	Exit Loops.....	27-28
	Accessory Wiring.....	29
	Locks, Receivers, Photocell Sensors.....	30
	Safety Edge, Fire Box, keypad, Access Controllers.....	31
	Battery, Solar Panel.....	32
TROUBLESHOOTING	Circuit Board Light Status Chart / Alarm Sounds.....	33
	Troubleshooting.....	34-35
	Maintenance.....	36
	Warranty.....	37
	Notes.....	38

GATE OPERATOR OVERVIEW

Power Input	110-120V AC, CM6-ACFP: 7 Amps, CM6-DCFP: 15 Amps
System Operating Voltage	CM6-DCFP: 24V DC
Maximum Output Current	30 amp, Fuse: 24V DC 30 amp
Dimensions	16.5" x 20" x 24"(L x W x H)
Gate Type	Swing
Application	Residential/Commercial
Maximum Gate Weight	1000 lbs
Maximum Gate Length	18 Feet
Operating Temperature	-20°F to 140°F
Maximum Gate Travel Speed	Approximately 20 sec for 90° opening
Maximum Duty Cycle	Continuous
Inherent Entrapment Protection	Inherent Reverse Sensor System (Type A)
External Entrapment Protection	Photoelectric Sensor (Type B1)
Solar Ready	CM6-ACFP: No, CM6-DCFP: Solar Ready
Emergency Release	Foot Pedal Manual Release
UL Classes	I, II, III, IV
Warranty	5 Year Residential, 3 Year Commercial

PARTS LIST

Calimet Gate Operator, Swivel Arm, 2 Remote Controls, Photosensor and Reflector, Photosensor Mount (x2), Warning Sign (x2), Allen Wrench, Bolts (x6), Instruction Manual, Warranty Card

CM6-DCFP: Battery, Battery Circuit Board

SAFETY

Carefully read, follow, and accept all safety precautions and warnings before attempting to install and use a gate operator, incorrect installation can lead to severe injury or death.

- The gate operator should be installed by a trained gate technician; otherwise serious personal injury or property damage may occur.
- Installing a gate operator may require installation of standard 110V-120V AC electrical wiring. This work should only be performed by an experienced technician. Miswiring could cause personal injury or DEATH.
- Never let children operate the gate or play around the gate. Keep the remote control away from children.
- Always keep people and objects away from the gate. Cars, people, and other objects should never enter when the gate is closing.
- Verify that this operator is proper for the type, weight, and size of the gate.
- Make sure the gate has been properly installed and slides freely in both directions. Repair or replace all worn or damaged gate hardware prior to installation.
- Test gate operator monthly. The gate must reverse when it comes in contact with a solid object, or stop when an object activates the non-contact sensors. After adjusting the force or travel limit, re-test the gate operator. Failure to maintain the gate operator properly can increase the risk of injury or death.
- Use the emergency release only when the gate is not moving.
- Keep the gate properly maintained. Read the owner's manual on how to maintain your gate. Have a certified service technician make repairs or install gate operator hardware.
- The gate entrance should be used for vehicles only. Pedestrians should use a separate entrance.
- Gate operators can use a huge amount of force to open and close a gate. Therefore, safety features must be taken into consideration when installing and using a gate operator. Specific safety features include: photoelectric sensors, edge sensors (contact), moving gate warning signs, guards for exposed rollers, screen mesh, vertical posts, and more.
- The gate must be installed in a location so that enough clearance is supplied between the gate and adjacent structures when opening and closing to reduce the risk of entrapment.
- A minimum of two (2) WARNING SIGNS shall be installed in the area of the gate. Each placard should be visible by persons located on the side of the gate on which the signs are installed.
- Access controls intended for users must be located at least 6 feet (1.8m) away from any moving part of the gate and where the user is prevented from reaching over, under, around, or through the gate to operate the controls.
- Keep these instructions.

UL325 Class Types & Entrapment Protection

UL 325 standard is a safety standard for electric gate openers. For full instructions, visit the UL325 website.

REQUIRED ENTRAPMENT PROTECTION

- A - Inherent (built-in) Entrapment protection System
- B1 - Non-contact sensor such as a photo-eye or equivalent
- B2 - Contact sensor such as edge sensor or equivalent
- C - Inherent adjustable clutch or pressure relief device
- D - Actuation device requiring continuous pressure to maintain gate motion
- E - Inherent Audio Alarm

Class I - Residential Locations & Class II - Commercial Locations / Multi-family housing

Slide Gates: Primary Device: A | Secondary Device (one required): B1, B2, D

Swing Gates: Primary Device: A, C | Secondary Device (one required) A, B1, B2, C, D

Class II - Commercial Locations / Multi-family housing

Slide Gates: Primary Device: A | Secondary Device (one required): B1, B2, D

Swing Gates: Primary Device: A, C | Secondary Device (one required) A, B1, B2, C, D

Class III - Industrial Locations / Limited Access Vehicular Gates

Slide Gates: Primary Device: A, B1, B2 | Secondary Device (one required): A, B1, B2, D, E

Swing Gates: Primary Device: A, B1, B2, C | Secondary Device (one required) A, B1, B2, D, E

Class IV- Guarded Industrial / Restricted Access Locations

Slide Gates: Primary Device: A, B1, B2, D | Secondary Device (one required): A, B1, B2, D, E

Swing Gates: Primary Device: A, B1, B2, C, D | Secondary Device (one required) A, B1, B2, C, D, E

NOTE: The same type of device shall not be utilized for both the primary and secondary entrapment protection means. Use of a single device to cover both the opening and closing directions is in accordance with the requirement; however, a single device is not required to cover both directions.

Requirements for UL Compliant Installation

- A minimum of two (2) warning signs shall be installed, one on each side of the gate where easily visible.
- The gate must have sufficient room when opening and closing. Swinging gates should open inwards and not into public access areas. The gate must be properly installed and move freely in both directions.
- Install the gate operator only when: 1) The operator is appropriate for the construction of the gate and the usage Class of the gate, 2) All openings of a horizontal slide gate are guarded or screened from the bottom of the gate to a minimum of 4 feet (1.2 m) above the ground to prevent a 2-1/4 inch (57.15 mm) diameter sphere from passing through the openings anywhere in the gate, and in that portion of the adjacent fence that the gate covers in the open position, 3) All exposed pinch points are eliminated or guarded, and 4) Guarding is supplied for exposed rollers, could be UL approved
- The gate must be properly installed and work freely in both directions prior to the installation of the gate operator. Do not over-tighten the operator clutch or pressure relief valve to compensate for a damaged gate.
- For gate operators utilizing Type d protection: 1) The gate operator controls must be placed so that the user has full view of the gate area when the gate is moving, 2) The placard as required by 52.1.1.6 shall be placed adjacent to the controls, 3) An automatic closing device (such as a timer, loop sensor, or similar device) shall not be employed, and 4) No other activation device shall be connected.
- Controls must be far enough from the gate (at least six feet) so that the user is prevented from coming in contact with the gate while operating the controls. Controls intended to be used to reset an operator after 2 sequential activations of the entrapment protection device or devices must be located in the line-of-sight of the gate. Outdoor or easily accessible controls shall have a security feature to prevent unauthorized use.
- For gate operators utilizing a non-contact sensor in accordance with 30A.1.1: 1) See instructions on the placement of non-contact sensors for each Type of application, 2) Care shall be exercised to reduce the risk of nuisance tripping, such as when a vehicle, trips the sensor while the gate is still moving, and 3) One or more non-contact sensors shall be located where the risk of entrapment or obstruction exists, such as the perimeter reachable by a moving gate or barrier.
- For a gate operator utilizing a contact sensor in accordance with 30A.1.1: 1) One or more contact sensors shall be located at the leading edge, trailing edge, and post mounted both inside and outside of a vehicular horizontal slide gate. 2) One or more contact sensors shall be located at the bottom edge of a vehicular vertical lift gate. 3) One or more contact sensors shall be located at the pinch point of a vehicular vertical pivot gate. 4) A hardwired contact sensor shall be located and its wiring arranged so that the communication between the sensor and the gate operator is not subjected to mechanical damage. 5) A wireless contact sensor such as one that transmits radio frequency (RF) signals to the gate operator for entrapment protection functions shall be located where the transmission of the signals are not obstructed or impeded by building structures, natural landscaping or similar obstruction. A wireless contact sensor shall function under the intended end-use conditions.

Requirements for UL Compliant Installation

- The gate operator is intended for installation only on vehicular gates. Pedestrians must access a separate entrance. The pedestrian entrance shall be designed for pedestrian usage. The gate must be installed in a location so that pedestrians will not come in contact with the vehicular gate during the entire path of travel of the vehicular gate.
- The Stop and/or Reset button must be located in the line-of-sight of the gate. Activation of the reset control shall not cause the operator to start.
- The gate must be installed in a location so that enough clearance is supplied between the gate and adjacent structures when opening and closing to reduce the risk of entrapment. Swinging gates shall not open into public access areas.

Before the Gate Operator Installation

Gate Structure

Confirm that the gate operator being installed is appropriate for the gate type, weight and size. The gate should be mounted and moving freely. There should be little resistance in the movement of the gate. The gate and post must be suitable for being automated. Check that the structure is sufficiently strong and stable, and that its dimensions and weights conform to those listed in the specifications table of this document. Any worn or damaged gate hardware must be repaired or replaced before installing the gate operator.

Secure outdoor or easily accessed gate operator controls in order to prohibit unauthorized use of the gate.

Vehicular gates should be constructed and installed in accordance with the ASTM F2200 construction standards.

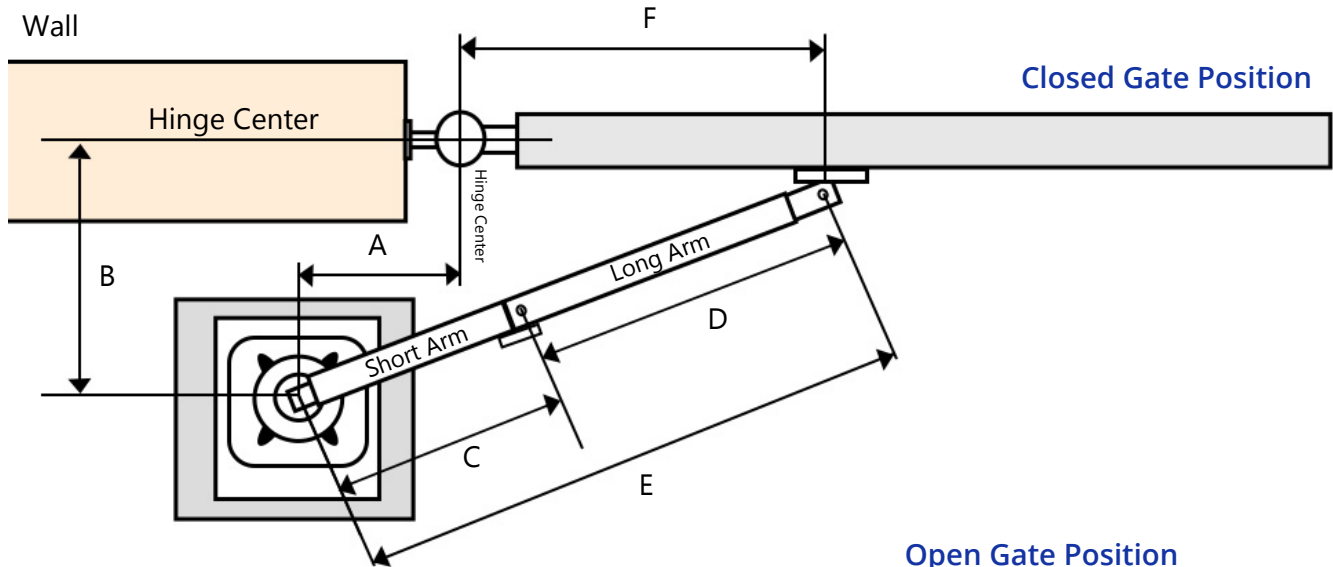
Electricity

The CM6 is powered by 110V-120V AC power. If you have not already done so, and you are not using solar, wire a waterproof outlet near the gate following proper safety standards for your area. If you are not experienced with this type of wiring or if your area requires it, hire a professional electrician to perform this as well as wire in the CM6 gate operator. Make sure your electrician takes into account the voltage drop involved in running many feet of wire to your installation location. If an insufficient gauge of wire is used, the gate operator may have insufficient power.

The gate operator must be disconnected from the power source before the installation. This also includes gate operator accessories.

Step 1: Standard Installation

Refer to the illustrations below to determine the measurements of the gate operator and concrete pad.



A. 14" minimum

B. 27"

C. Length of C = $E * 40\%$.

The length of C is 40% of E. Arm should be 90° from gate when open and straight when closed. Distance from the center of the gate operator output shaft to the swivel arm nut. Note: C is the short part of the swivel arm.

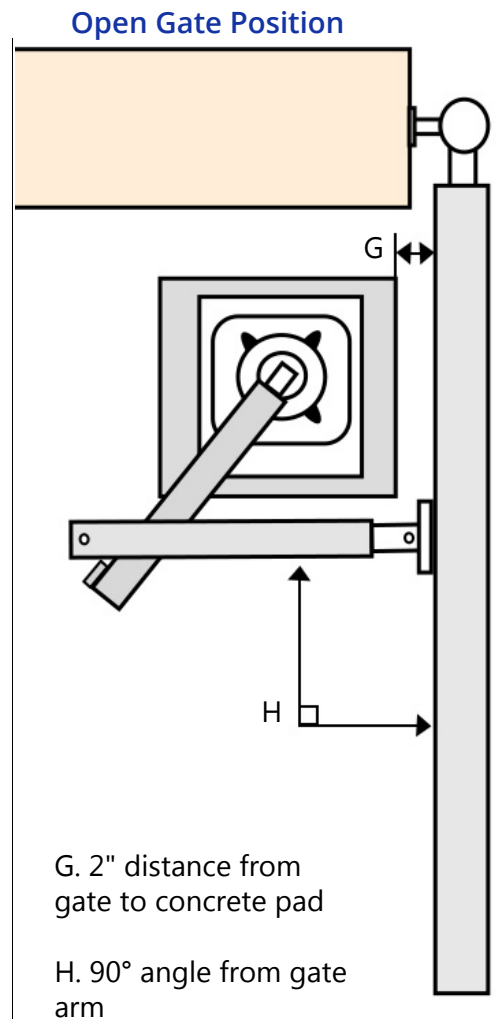
D. Length of D = $E * 60\%$.

The length of D is 60% of E. Arm should be 90° from gate when open and straight when closed. Distance from the swivel arm nut to the center of the gate bracket. Note: D is the long part of the swivel arm.

F. If the gate length is less than 10 feet, F should be at least 1/4 the gate length.

If the gate length is greater than 10 feet, F should be at least 1/3 the gate length.

For uphill or heavy gates, F should be at least 1/3 gate length.

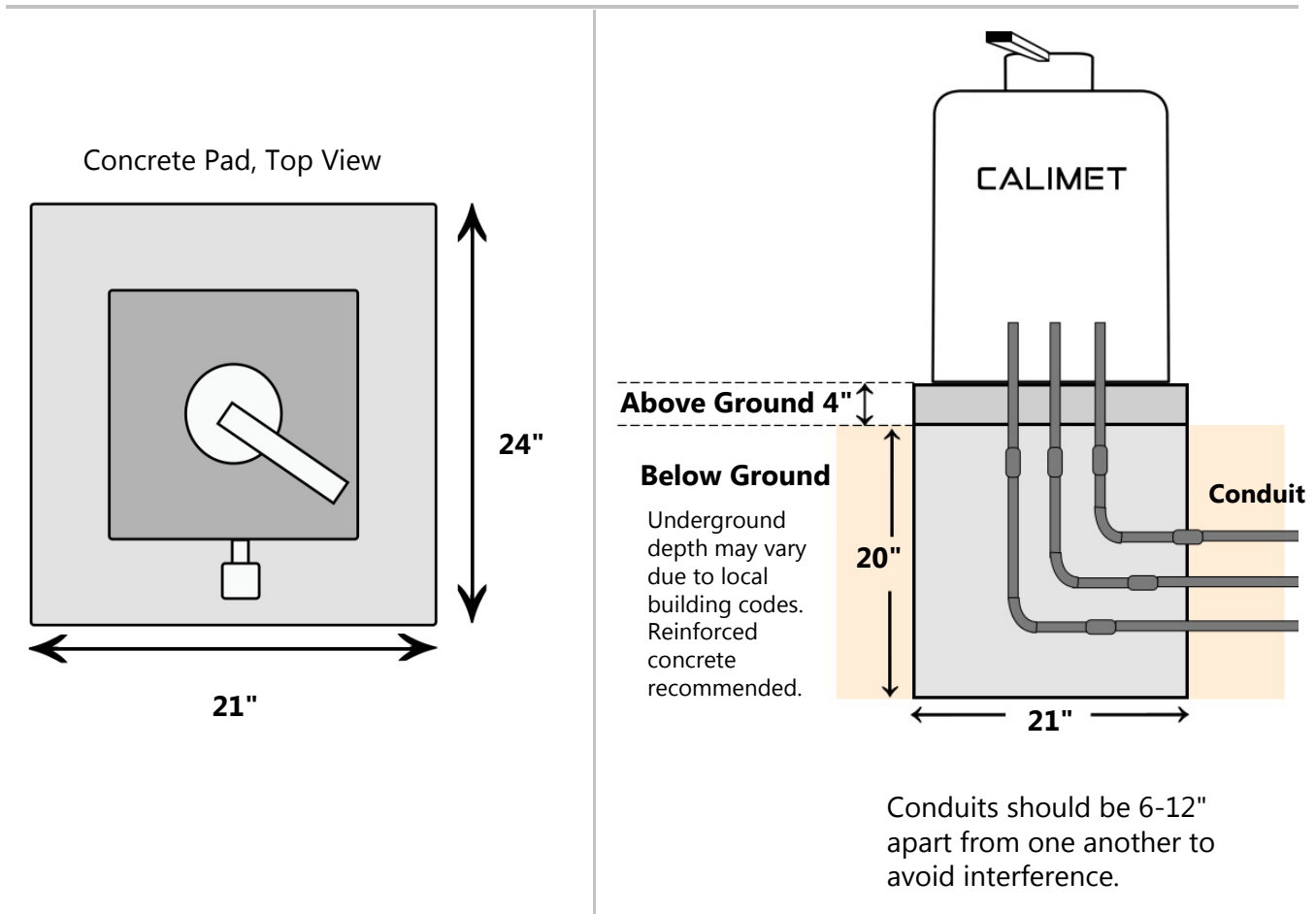


G. 2" distance from gate to concrete pad

H. 90° angle from gate arm

Step 2: Install a Concrete Pad

1. Lay out a concrete pad. Requires a minimum of 21"(length) x 24"(width) x 24"(20" depth below ground, 4" above ground). See Step 1 for the position of the concrete pad.
2. Install the electrical conduit. One conduit is required for a single gate. For double gates, add another conduit. For underground loops, add another conduit.
3. Pour the concrete pad.
4. Use 4 wedge anchors 1/2" to secure the gate operator to the concrete. Figure A



CAUTION

Contact local underground utility locating companies before digging more than 12 inches deep to avoid damaging underground power, gas or other utility lines.



Figure A
Wedge Anchor
1/2"

Compact Installation

Install using compact installation ONLY when the space between the OPEN gate and wall is between 20-32", Figure A.

1. Cut the swivel arm to meet the size requirements. Figure B

Figure A: Open Gate Position

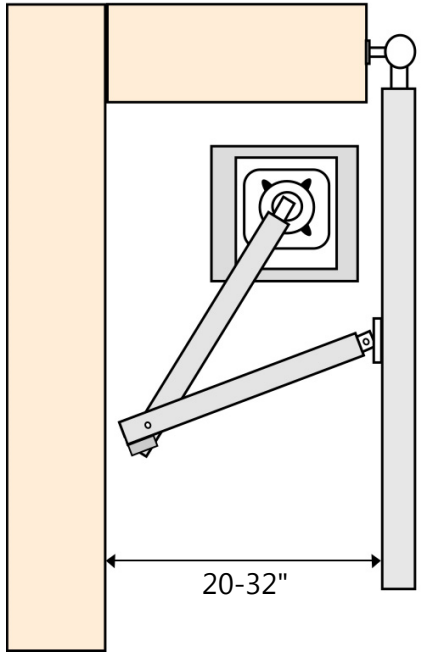
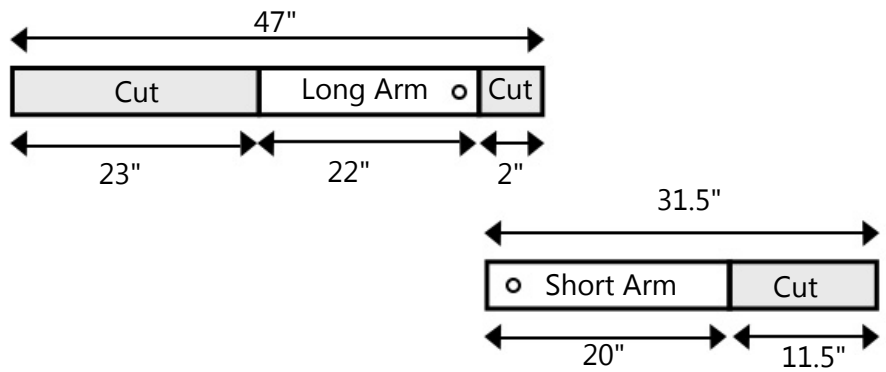
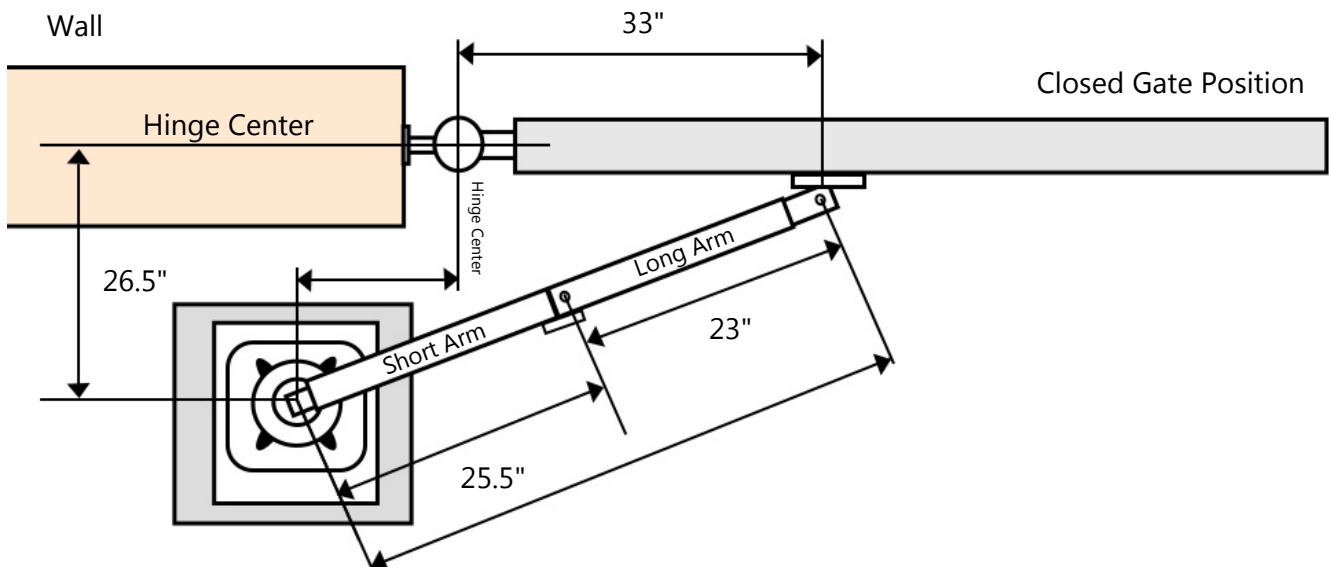


Figure B: Cut the Swivel Arm



2. Install the swivel arm in accordance to the measurements below.



Swivel Arm Positioning Tips

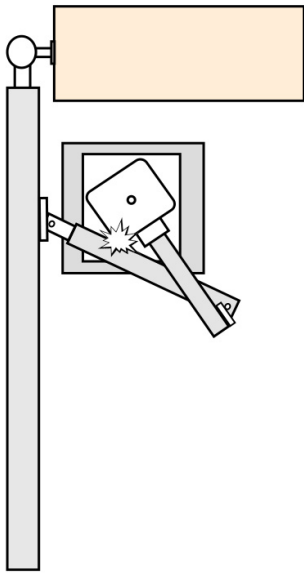


Figure A

A. DO NOT allow the arm to touch the gate operator's hood when the gate is in the open position.

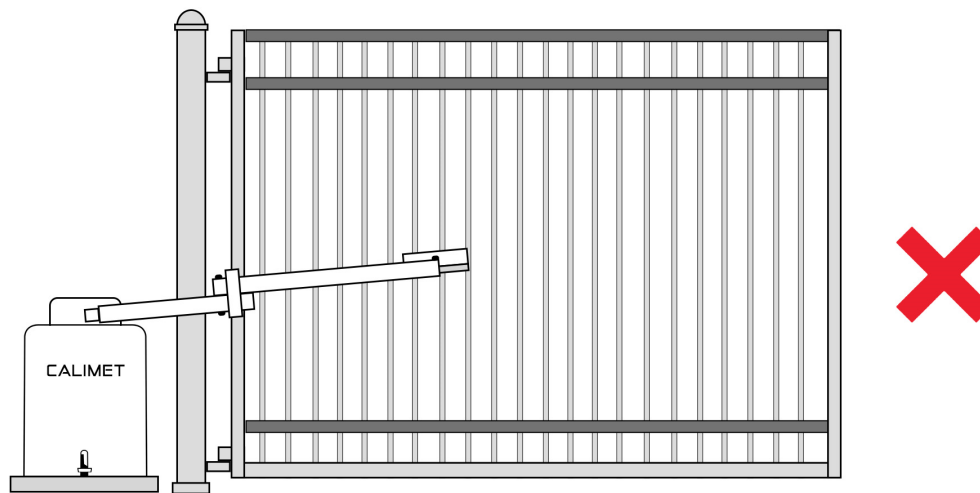
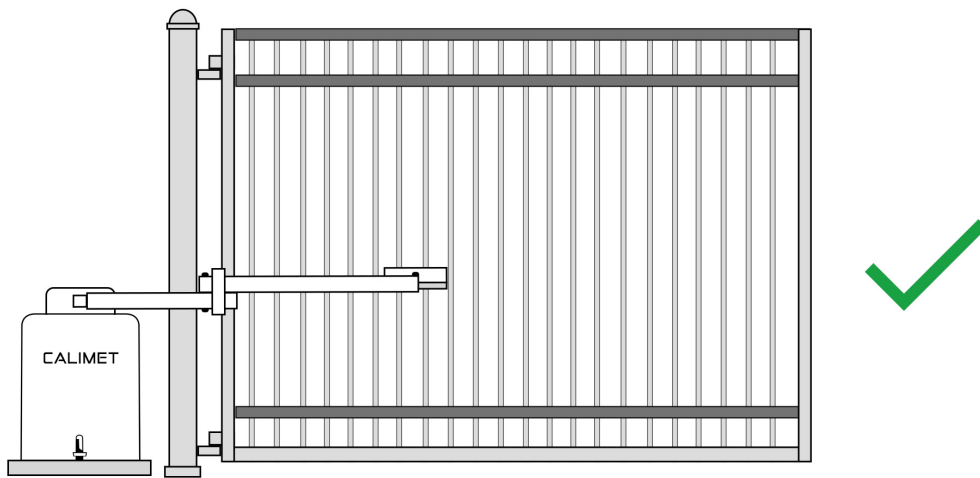
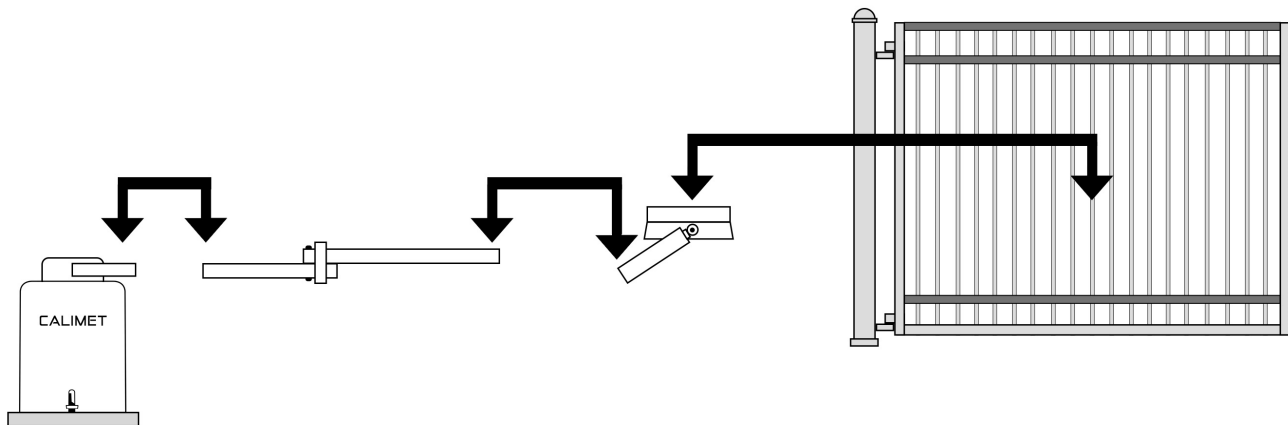


Figure 8: Swivel arm is incorrectly bent. Swivel arm must be straight.

Step 3: Weld the Door Arm

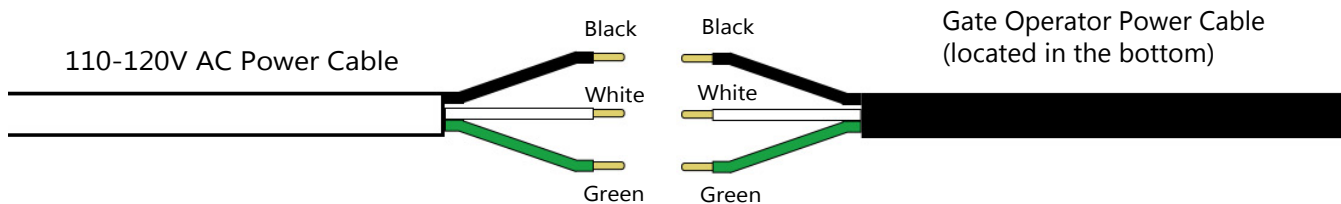


After you're satisfied with testing the arm in the full open and closed positions, weld the following:

1. Short arm to gate opener metal bar
2. Gate bracket to gate
3. Gate bracket to long arm

Step 4: Connecting the Power

1. Use UL approved electrical wires, stranded copper, connected to 110-120V AC electricity. Electrical wires MUST have a minimum capacity for 15 Amp current. See Figure A below for the correct electrical wire gauge size. Wires must be placed in a PVC or other underground conduit.
2. Turn off the AC power from the main power source circuit breaker.
3. Connect the green wire to the green wire (GROUND) wire using a wire nut (Figure B).
 - a. Alternative: connect the green wire to the earth ground rod and AC ground wire nut. Note: The earth ground rod can be grounded to the chassis.
4. Connect the white wire to the white wire (NEUTRAL) using a wire nut.
5. Connect the black wire to the black wire (HOT/LINE) using a wire nut.



6. All operators MUST be properly grounded in order to prevent an electrical charge. Must use a dedicated circuit for power supply.
7. Turn ON AC power from the main power source.
8. Turn the power switch on the gate operator to the ON position. For DCFP model gate operators, turn the battery switch to the ON position, Figure C

Electrical Wire Gauge Chart

Distance	Gauge
0 - 200 ft	14 AWG
201-400 ft	12 AWG
401-650 ft	10 AWG
651-1000 ft	8 AWG
1001-2000 ft	4 AWG

Figure A

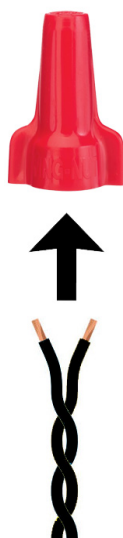


Figure B

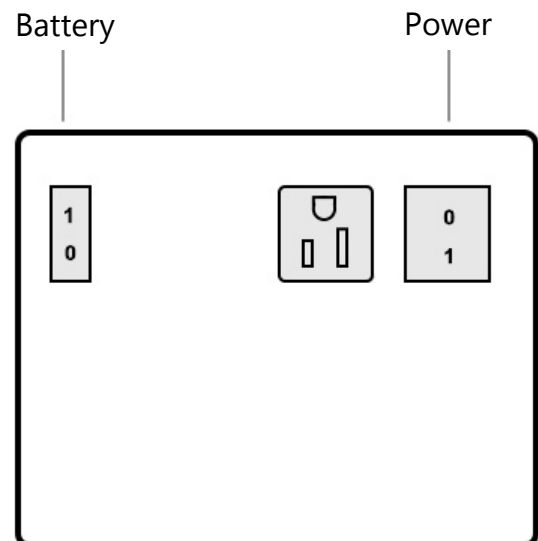


Figure C

Step 5: Set the Gate Open Direction

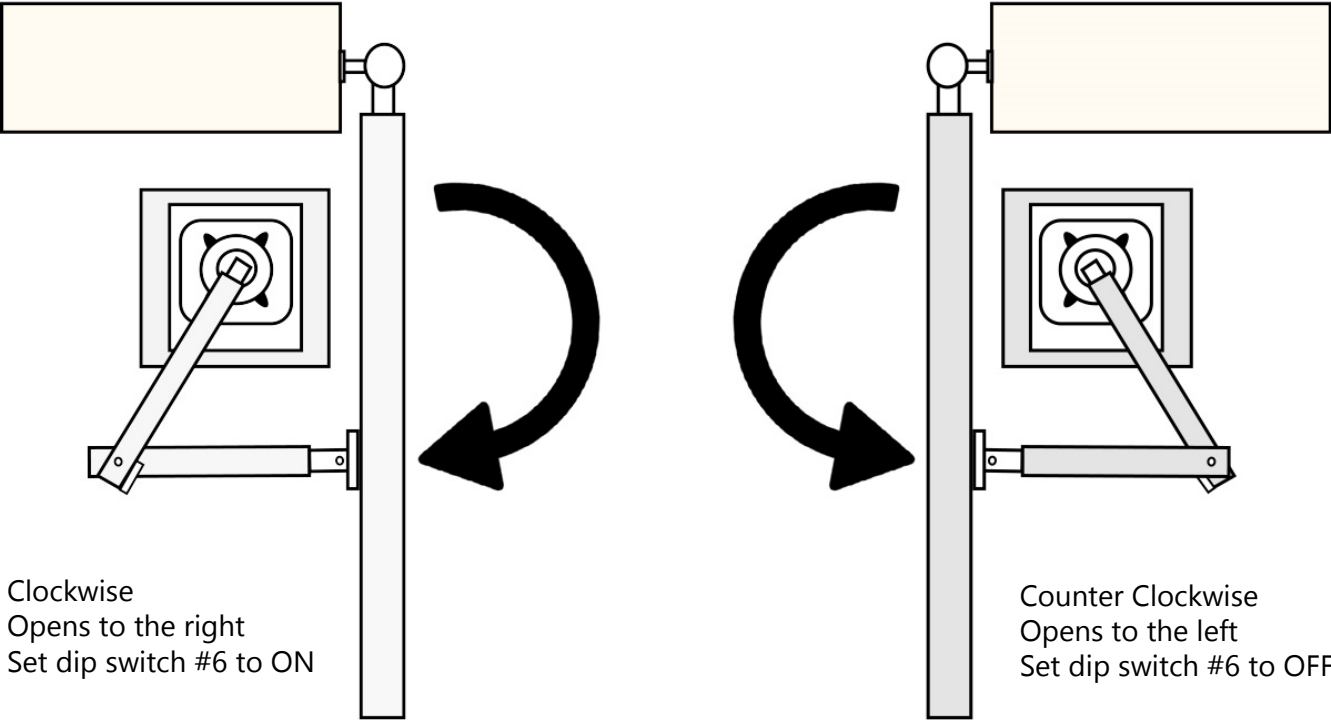
Determine which direction your gate opens when viewed from the inside

Dip Switch #6 (Figure A) on the bottom of the gate operator circuit board controls the open direction.

- ON = opens to the right
- OFF = opens to the left

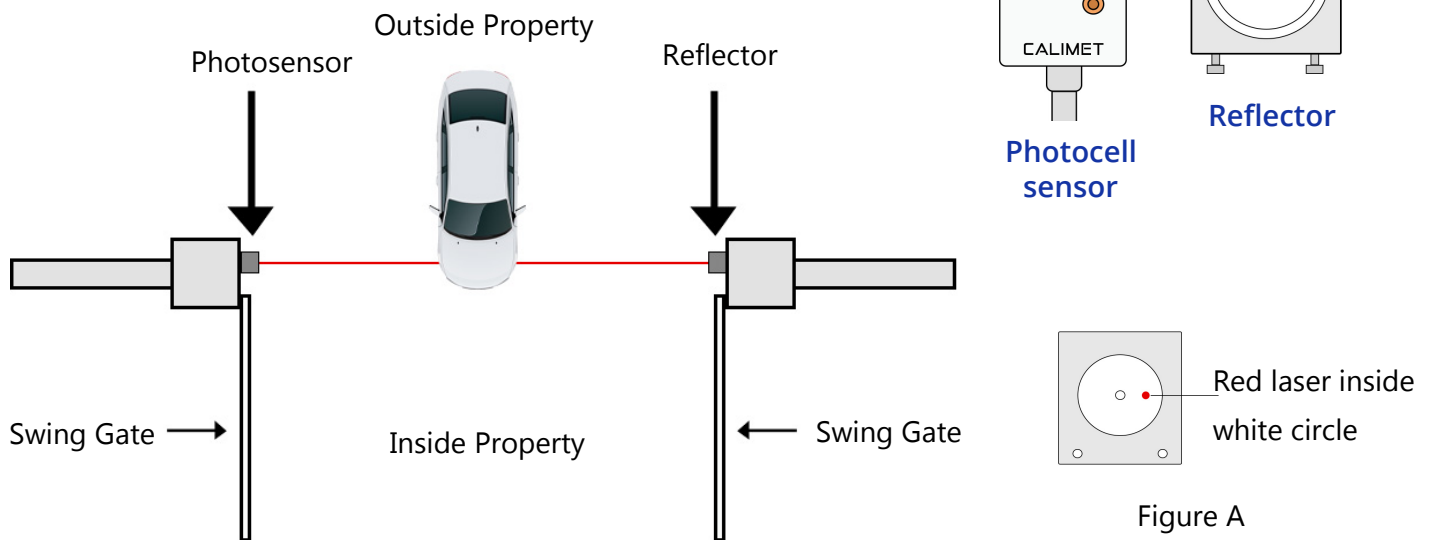


Figure A



Step 6: Install the Photocell Sensor

The photocell sensor is a safety device that prevents the gate from hitting a car when a gate is closing. The photocell sensor emits an invisible infrared beam that detects when objects pass through.



1. Plug the photocell sensor cable to the back of the gate opener, behind the circuit board. You should see a green input with the label: "MON-OPEN/MON-CLOSE, COMMON, MON-24VDC".
2. Press the reset button on the gate operator control board.
3. Mount the photocell sensor OUTSIDE of your property on the post or wall next to your gate, 21" from the ground.
4. Press the orange button on the photo eye to turn on the alignment laser.
5. Mount the reflector to the opposite side. Make sure the alignment laser hits inside the circle of the reflector. Figure A, Figure B
6. Press the orange button on the photocell sensor to turn off the alignment laser. Important! Must alignment laser must be off. Figure C

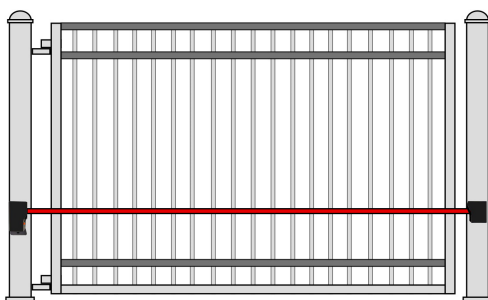


Figure B

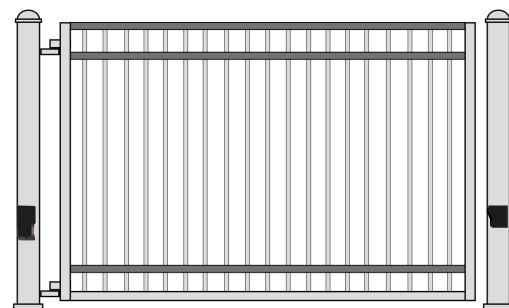
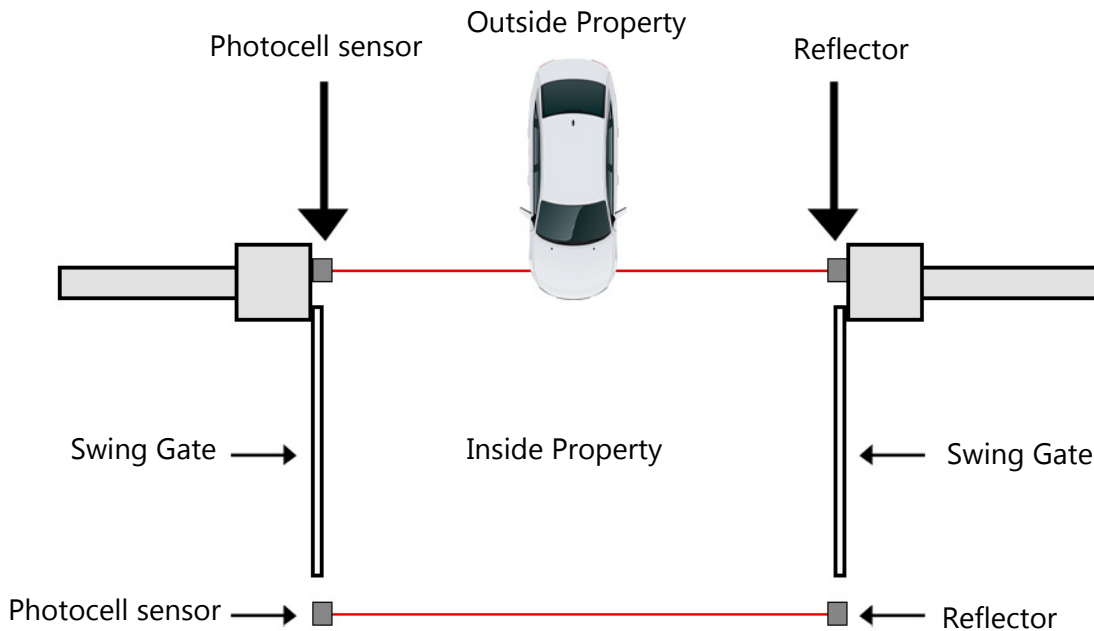


Figure C

Installing a secondary Photocell Sensor (Optional)

A second photocell sensor can be installed inside the gate to monitor the OPEN cycle.

This photocell sensor goes inside your property, past the gate's fully open position. If the photocell sensor's cable isn't long enough you will need to extend (splice) the wires by joining them with another 20-22 AWG wire for the secondary photocell sensor to be able to reach the gate operator input.



Secondary Photocell Sensor Wiring

Use the same green terminal block input as your primary photocell sensor. Each input can have more than 1 wire inserted.

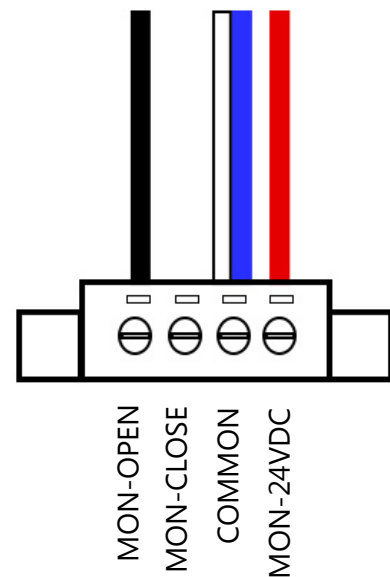
Differnet model photocell sensors contain 3 or 4 wires. Depending on how many your photocell sensor contains, follow the wiring diagram below.

4 Wires:

- Red/Brown > MON_24VDC
- Blue and White > COMMON
- Black > MON_OPEN

3 Wires:

- Red/Brown > MON_24VDC
- Blue > COMMON
- Gray > MON_OPEN

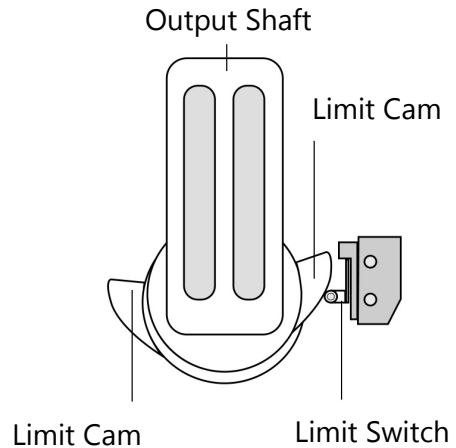


Step 7: Adjust Gate Travel Limits

The gate travel limit controls the position of where the gate opens and closes.

1. Use a screwdriver to loosen the 3 screws on the top limit cam. Do the same for the bottom limit cam.

TIP: For the next step below, use the OPEN, CLOSE, STOP buttons on the circuit board for efficient positioning. Press the STOP button before the gate hits the end. The gate should stop about 1/2 an inch before it hits the end. The gate should not touch the end of the wall or post.



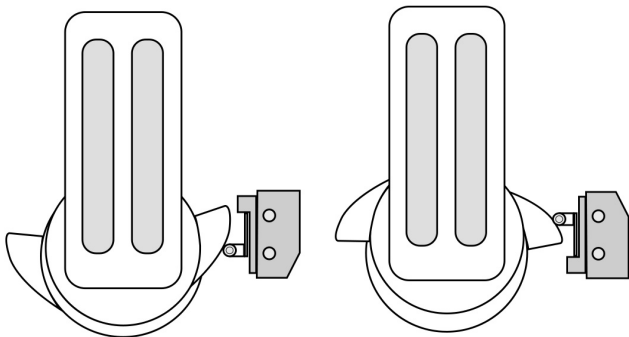
2. If gate opens to the right (clockwise):

The top limit cam controls the open limit

- Turn the top limit cam counter clockwise to increase open distance ↺
- Turn the top limit cam clockwise to decrease open distance ↻

The bottom limit cam controls the close limit

- Turn the bottom limit cam clockwise to increase close distance ↻
- Turn the bottom limit cam counter clockwise to decrease close distance ↺



Top limit Cam,
Gate fully opened

Bottom Limit Cam,
Gate fully Closed

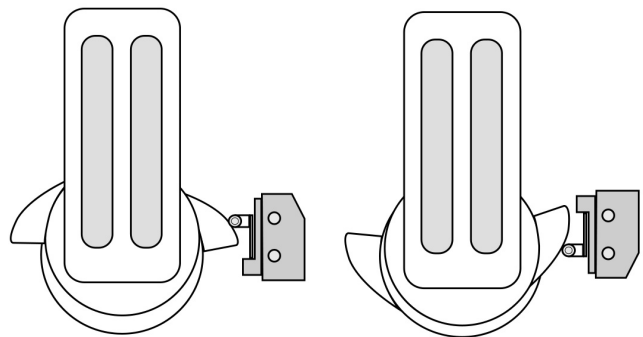
2. If gate opens to the left (counter clockwise):

The top limit cam controls the close limit

- Turn the top limit cam counter clockwise to increase close distance ↺
- Turn the top limit cam clockwise to decrease close distance ↻

The bottom limit cam controls the open limit

- Turn the bottom limit cam clockwise to increase open distance ↻
- Turn the bottom limit cam counter clockwise to decrease open distance ↺



Bottom Limit Cam,
Gate fully Opened

Top Limit Cam,
Gate fully Closed

3. Use the screwdriver and screw back in the limit cam screws.

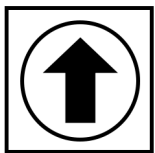
Step 8: Force Adjustment

The Electronic Reversing Device (ERD) is a feature on the circuit board which detects when the gates comes in contact with an obstruction, causing the gate to reverse. These are the 2 blue knobs on the circuit board.

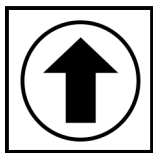
The open and close knobs determine the amount of force required to reverse the gate (figure 21). We generally recommend leaving the knob at 50. You may adjust the positions based on your particular gate.

If the gate reverses without touching an obstruction, the ERD is set too low. If the gate does not reverse when it hits an obstruction, the ERD is set too high.

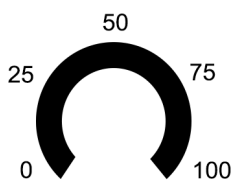
Test ERD every 6 months.



- OPEN ERD +



- CLOSE ERD +



Normal = 50 is the default ERD force and is suitable for most gates

Turn Left/Counter-Clockwise = Less force to stop the gate. Recommended for lighter/small sized gates.

Turn Right/Clockwise = More Force required to stop the gate. Recommended for heavier/long gates.

Obstruction Test

1. Place a light object (ex. chair or trash can) between the open gate and the post.
2. Close the gate. The gate should stop and reverse when it touches the object. If the gate does not reverse when it touches the object, press the STOP button on the circuit board. Reduce the ERD force by turning the knob counter-clockwise.
3. Do the same test again for the open direction.
4. Test the gate operator after any adjustments are made.

WARNING

- Never increase force beyond the minimum amount required to move the gate. Too much force may seriously injure or kill people.
- Never use force adjustments to compensate for a improperly installed, improperly maintained, or a damaged gate. The gate must normally move freely with no obstructions.
- The ERD must be tested after making any changes. The gate must reverse when it comes in contact with an object.

Step 9: Install Warning Signs

Warning signs are to alert people that a possible hazard exists with moving gates, so that appropriate action can be taken to avoid injury.

Install the 2 supplied warning signs in locations where the signs are visible by people on both sides of the gate. They may be installed directly on the gate, or a nearby wall or post.

Use screws (not supplied) to install the warning signs.



Finished! You are now finished installing your gate operator.

See the next page for post-installation instructions.

After Installation

Accessories

Additional accessories such as keypads, exit loops, and access controllers can be purchased and installed to your gate operator. Ask your installer for more information or visit calimetco.com/accessories to view all available accessories.

Warranty

Register your warranty using the warranty card included in the box. This will require the serial number of the gate operator which is located underneath the black cover, outside the circuit board compartment. After you're done, mail in your warranty to the address specific on the card.

Additionally, you may register your warranty online by visiting calimetco.com/gate-operator-warranty-registration.

Auto-Close Timer

Most homeowners prefer the gate to close automatically after they drive through it. See the "Dip Switch Features" page, specifically the "2. Timer" section to set up the auto-close timer on your gate operator.

Dual-Gate Installation

For double gates, visit the "Dual Gate Setup" page for more installation instructions.

HomeLink

Most modern cars come with a feature called Homelink that lets you open your gate by pressing a button on your car. Calimet gate operators are compatible with HomeLink. Visit homelink.com/program/vehicle and enter your car model to view specific instructions.

Safety

Read this instruction manual to learn the common features of a gate operator and their functions. Learn how to turn off the power and how to use the emergency release pedal in cases of a power outage. Keep your gate maintained by following the "maintenance" page instructions.

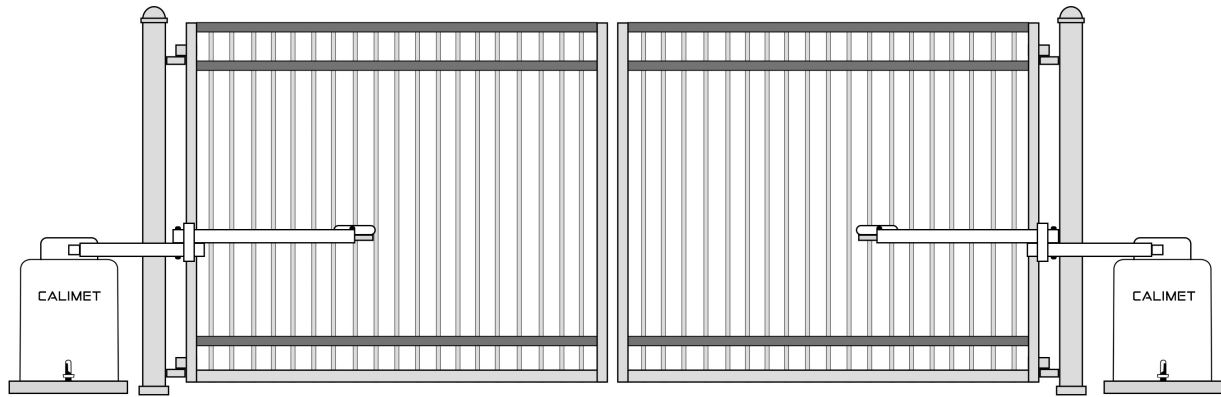
Read the "Safety" page to learn the dangers of a moving gate. Keep all children away from moving gates. Do not allow children to play on or near the gate or operate the remote controls.

Installers

Fill out the "notes" page with the gate operator model and serial number and provide them with your contact information.

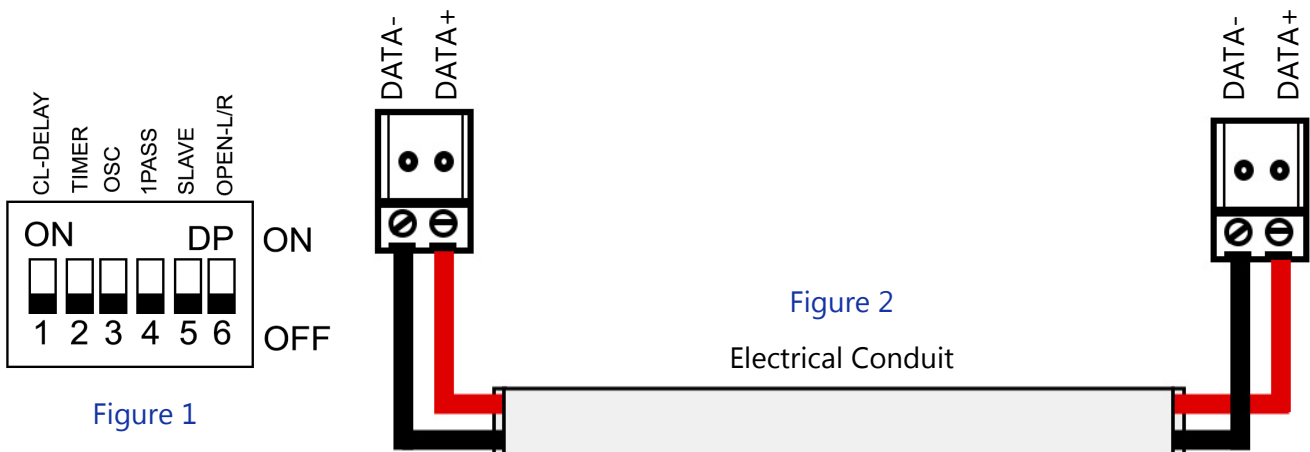
Leave instruction manual and product literature with the owner or end user.

Dual Gate Setup



This setup is for dual swing gates. A single button press of the remote control can open both gates. This requires 2 gate operators. One gate operator is the "Primary", and the other is the "Secondary".

1. On the Secondary gate operator circuit board, set dip switch #5 to ON (Figure 1).
2. Press the reset button on the Secondary gate operator circuit board.
3. A 20 gauge (or higher) 2 conductor electrical wire is required.
4. Locate the DATA- and DATA+ green terminal on the bottom left of the circuit board. (Figure 2). Use a flathead screwdriver to release the 2 locks on the top of the green terminal.
5. Using the electrical wire, connect the DATA+ on the primary gate opener, to the DATA+ on the secondary gate opener. Connect the DATA- on the primary gate opener to the DATA- on the secondary gate opener. The M/S link LED light should now be lit on both circuit boards.
6. Use the flathead screwdriver to close the two locks on the top of the green terminal.



7. Place the cable underground in an electrical conduit. This conduit must separate from the main 110-120V AC electricity conduit.

8. Make sure all remote controls, photocell sensors, loop detectors, and any other accessories are installed on the PRIMARY gate operator only. Only one photocell sensor is required. Finished.

Emergency Release

The emergency release foot pedal allows you to open the gate manually, such as in cases during a power outage and there is no electricity.

1. Step on the release pedal with your foot and move it down to the right until it is locked in. Figure C.

2. Push gate open using your hands.

When finished, step on the pedal and move it back to the top left. Figure B.

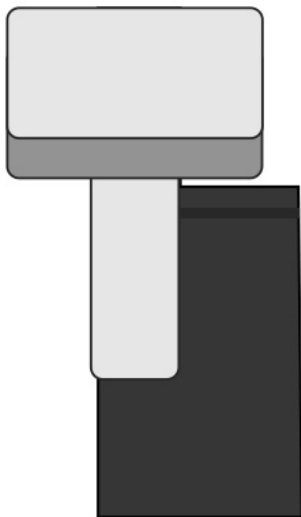
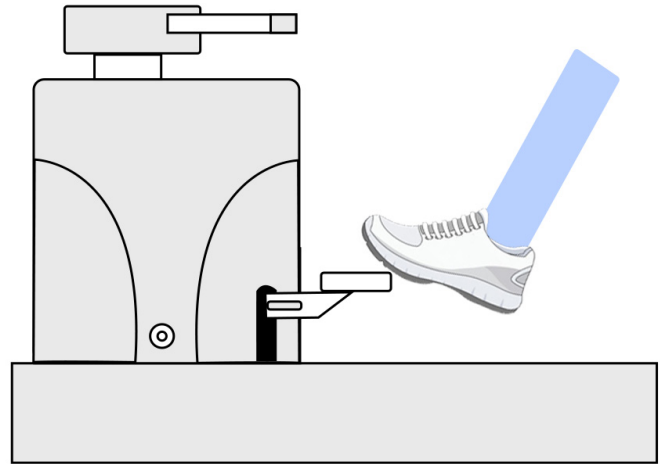


Figure B: Normal Position - Left side. The emergency release is not being used. The gate is locked in this position.

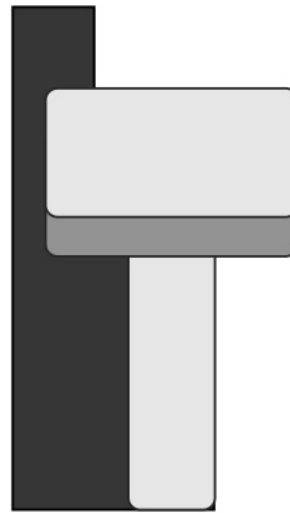


Figure C: Emergency Release - Right side. The emergency release is pressed down, allowing you to manually push open the gate.

PadLock

A padlock may be installed on the emergency foot pedal. There is a hole on the side of the pedal that allows a lock to be installed there to prevent unauthorized use of the foot pedal.

Dip Switch Features

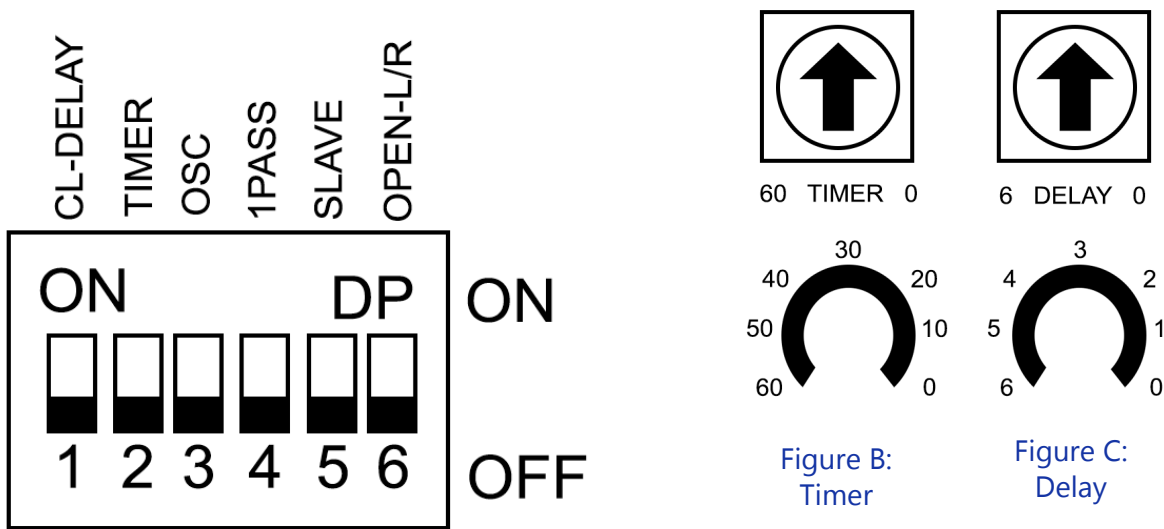


Figure A: DIP switches

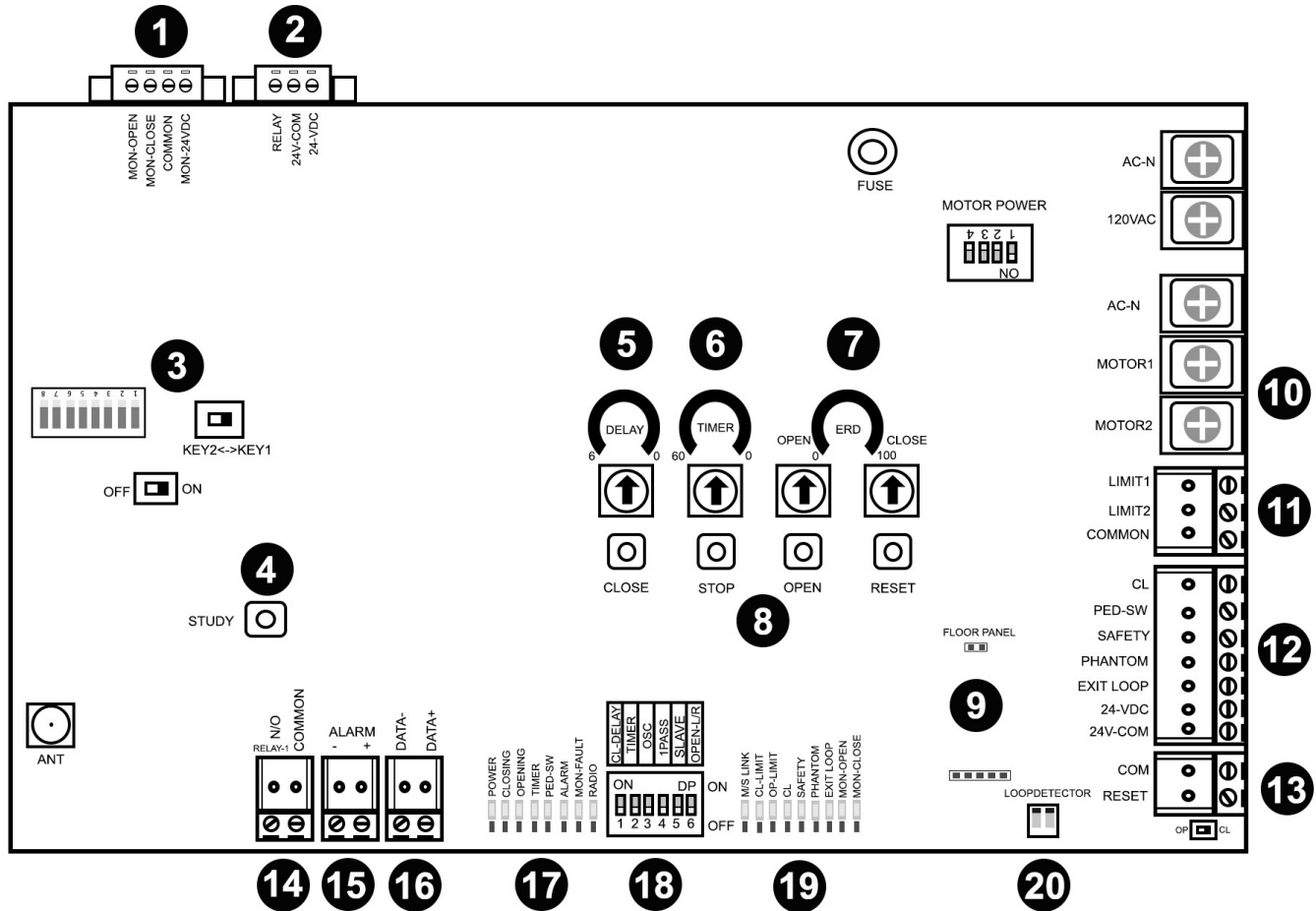
There are 6 dip switches located at the bottom of the circuit board, Figure A. Each switch controls a different feature of the gate operator.

Switch	Name	Description
1	CL-DELAY	Gate Closing Delay - switch to ON position, turn timer to 1- 6 seconds. Figure C. Useful for dual gate operators with locks, requiring one gate to close first before the other, also known as "Bipart Delay".
2	Timer	Auto-Close - automatically closes the gate after a timed delay. Set to ON and turn the blue TIMER knob anywhere from 1-60 seconds. Figure B.
3	OSC	Mid-Stop - allows the remote control to stop the gate when opening or closing. Press once to stop the gate, and press the remote again to reverse the gate.
4	1PASS	Anti-Tailgating System - when ON, after a vehicle has cleared the safety loop, the gate will start to close immediately. If a second vehicle crosses the loop while the gate is closing, the gate will stop. The second vehicle must get off the loop before the gate closes completely.
5	SLAVE	Dual Gate Installation - for the secondary gate operator only, set the #5 SLAVE switch to ON. If single gate installation, set to OFF.
6	OPEN L/R	Gate Open Direction - set the direction of which the gate opens when viewed from inside the property: Left or Right.

CM6-ACFP Circuit Board Layout

Gate Operator Model: [CM6-ACFP](#).

This is a picture of the control board. Use this for reference.

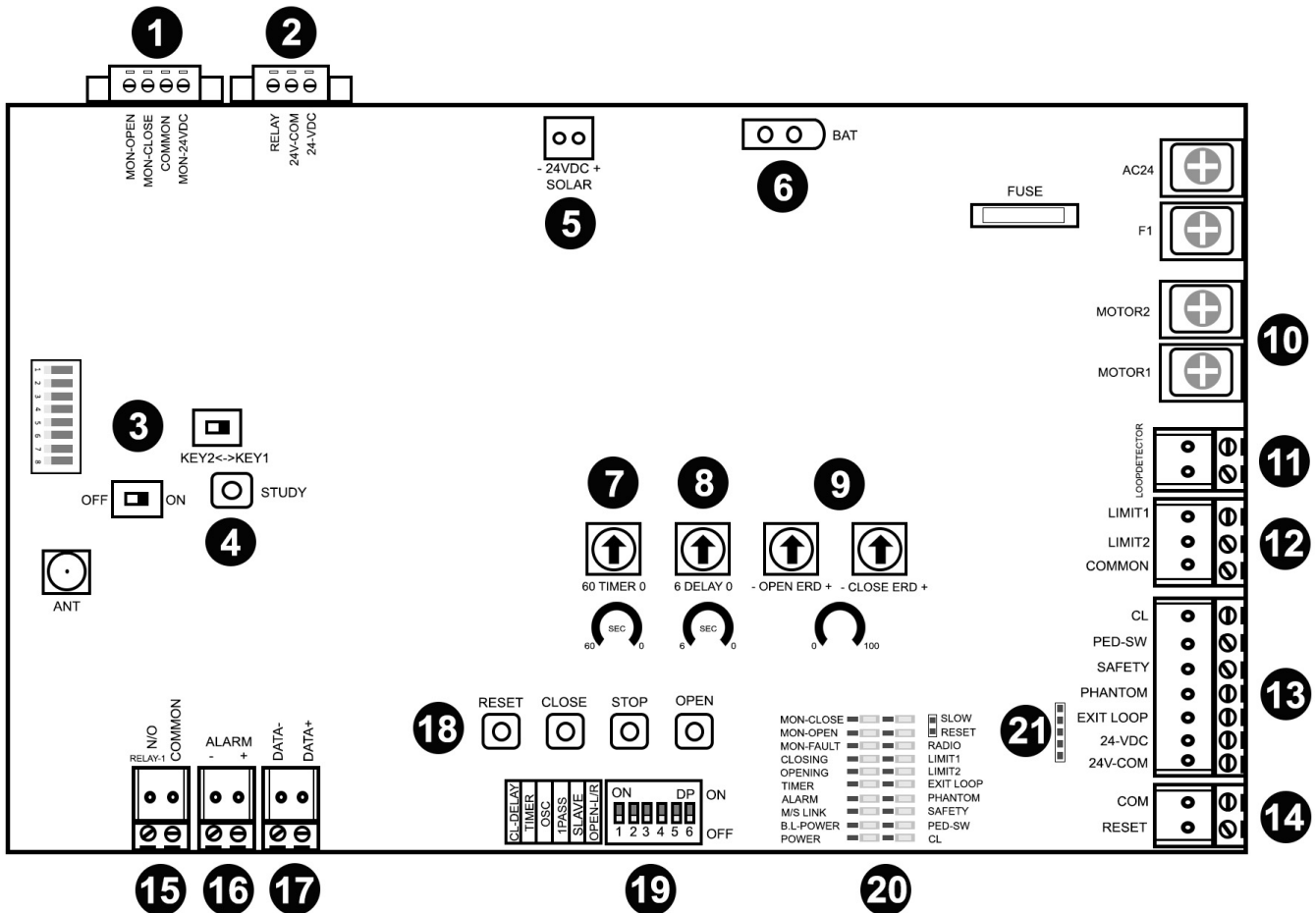


- | | |
|---------------------------------------|---|
| 1. Photocell Sensor Input | 11. Limit Switch Inputs |
| 2. External Keypad Input | 12. Loop Detectors Wire Input |
| 3. Remote Control Dip Switch Settings | 13. Common Input |
| 4. Remote Control Learn (Study) Setup | 14. Strobe Light Relay |
| 5. Delay Timer Knob | 15. Alarm Relay |
| 6. Auto Close Timer Knob | 16. Dual Gate Relay Inputs - M/S |
| 7. Open and Close ERD Knob | 17. Status Light Indicator |
| 8. Open/Close/Stop/Reset Buttons | 18. Dip Switches |
| 9. Plug-in Loop Detetcor Input | 19. Status Light Indicator |
| 10. Electric Lock Input | 20. Loop Wire Input for Plug-in Loop Detector |

CM6-DCFP Circuit Board Layout

Gate Operator Model: [CM6-DCFP](#).

This is a picture of the control board. Use this for reference.



- | | |
|--|---|
| <ol style="list-style-type: none"> 1. Photocell Sensor Input 2. External Keypad Input 3. Remote Control Dip Switch Settings 4. Remote Control Learn (Study) Setup 5. Solar Panel Wire Input 6. Backup Battery Wire Input 7. Auto Close Timer Knob 8. Delay Timer Knob 9. Open and Close ERD Knob 10. Electric Lock Input | <ol style="list-style-type: none"> 11. Loop Wire for Loop Detectors 12. Open/Close Limit Relay 13. Loop Detector Wire Relay Inputs 14. Common Global Input 15. Strobe Light Relay 16. Alarm Relay 17. Master/Slave Dual Gate Relay Inputs 18. Open/Close/Stop/Reset Buttons 19. Dip Switches 20. Status Light Indicator 21. Calimet Loop Detector Plugin Input |
|--|---|

Remote Controls

By default, the remote controls are already connected to the gate operator. You do not need to do any of the following steps unless you are adding more remote controls.

This gate operator can add up to 50 different remote controls. To add more than 50 remote controls, add a receiver, which can add up to 100 additional remote controls. Calimet remote controls use 418 MHz frequency with a 300' max distance

There are two ways to connect your remote control: Learn & Dip Switch.

Learn

Connect using Learn On your gate operator circuit board, look for the study key (Page 15, #4). Press and hold the button on the remote control. Press and hold the study key until the flashing light turns solid, about 2 seconds. Done, the remote is now connected to the gate opener.

Removing all existing remote controls Press the STUDY key on the gate operator circuit board and hold for 8 seconds. Done. All remote controls are now removed.

Dip Switch

Only the CM9-509 red remote controls can be installed using the dip switch method.

A. On your circuit board find the Dip Switch setup (Page 15, #3), turn the OFF/ON switch to the ON position.

B. Unscrew the back of the remote control to gain access to the control board. You should see 1-8 dip switches. Each switch has 3 positions: up, middle, bottom. Flip these 1-8 switches to any random position you'd like, see Figure A.

C. On the gate opener control board, look for the same 1-8 dip switches (Page 15, #3), and set the same combination as you did on the remote.

D. Finished.

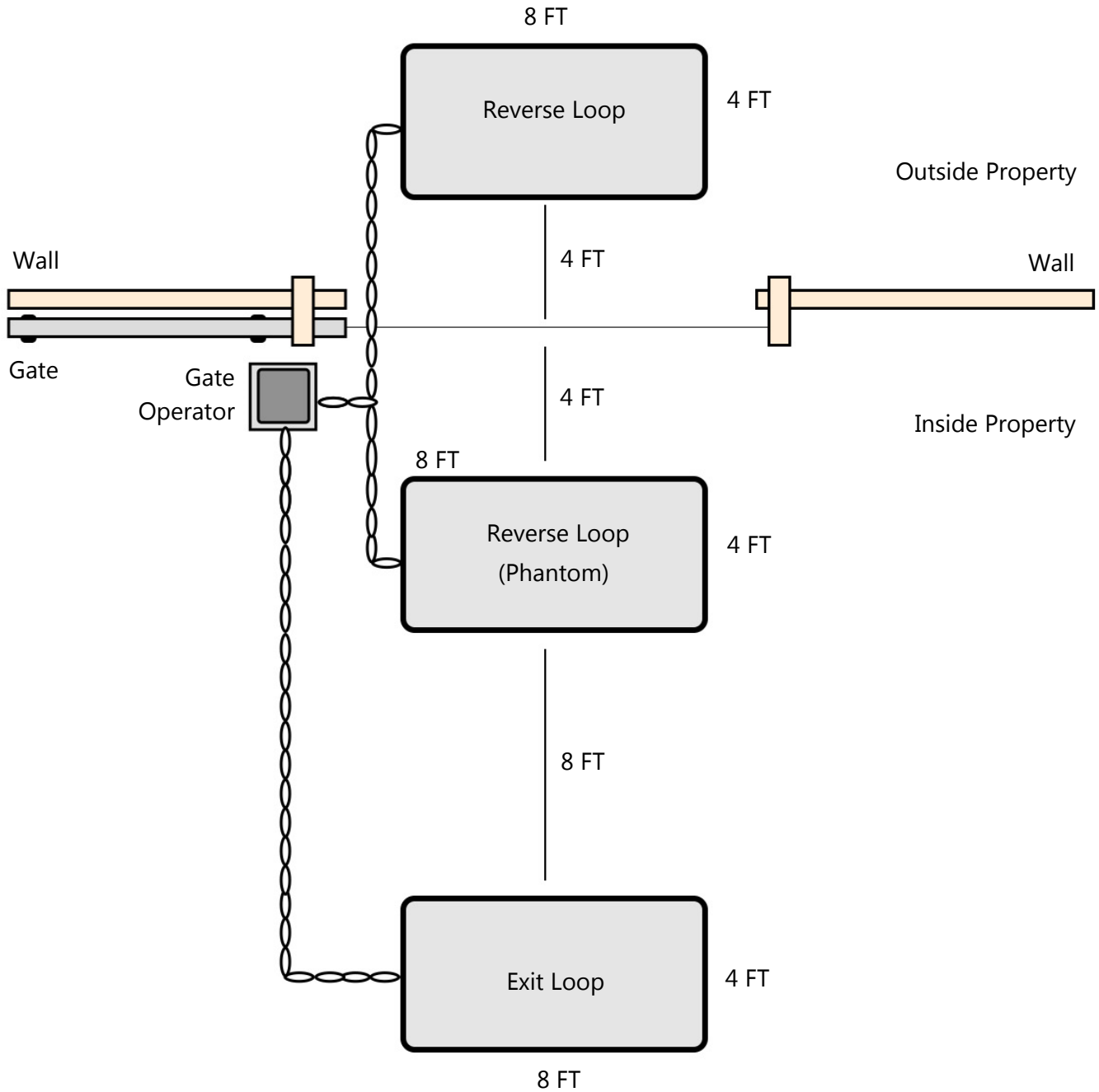


Figure A

Exit Loops

An exit loop is a device that opens the gate automatically when a car approaches the gate.

A reverse loop is a loop that reverses the direction of the gate if a car drives over it. It will also hold a gate open if a vehicle stops over the loop. If the gate is fully closed and a vehicle drives over it, the gate will not open.



Exit Loops

Loop wires are installed 1.5" underground by cutting the concrete with a circular saw. The typical size loop is 8x4'. Common loop wire size is 18 AWG. 3 layers of turns are required for a typical 4x8' loop. Place a plastic foam above the loop wire turns to hold it in place. The ends must be twisted back into the gate operator with a minimum of 6 twists per foot. The twisted ends must be placed inside a PVC conduit. Use sealant to close the ground once finished.

If you purchased a Calimet Brand Loop Detector Plugin, it is installed in the brackets below (figure A). The loop wires are installed in the LOOPDETECTOR Relay. See the loop detector instruction manual for more installation instructions.

For other brand exit loops or exit wands, use the Exit Loop relay, and the 24-VDC and 24V-COM if using the gate operator to power the device.

For reverse loops located on the inside of the gate, use the PHANTOM relay. For reverse loops located on the outside of the gate, use the SAFETY relay.

The exit loop relays are located on the bottom right of the gate operator circuit board.

Loop to Gate Operator Wiring Diagram

- Reverse Loop (outside) → SAFETY
- Reverse Loop (Phantom) (inside) → PHANTOM
- Exit Loop → EXIT LOOP

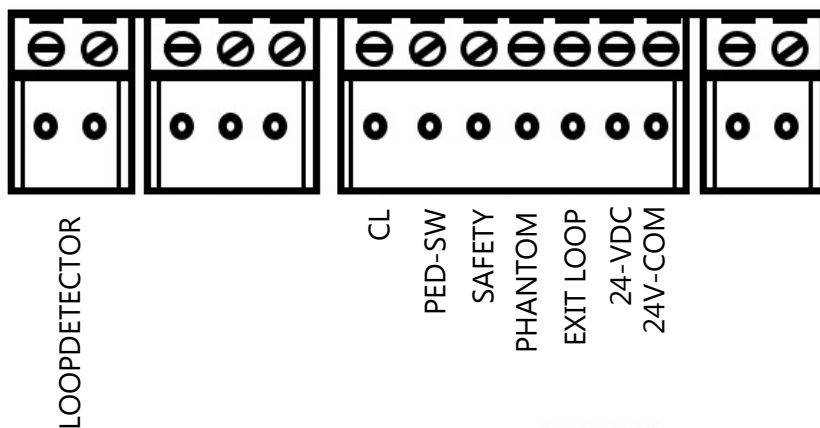


Figure A

Accessory Wiring

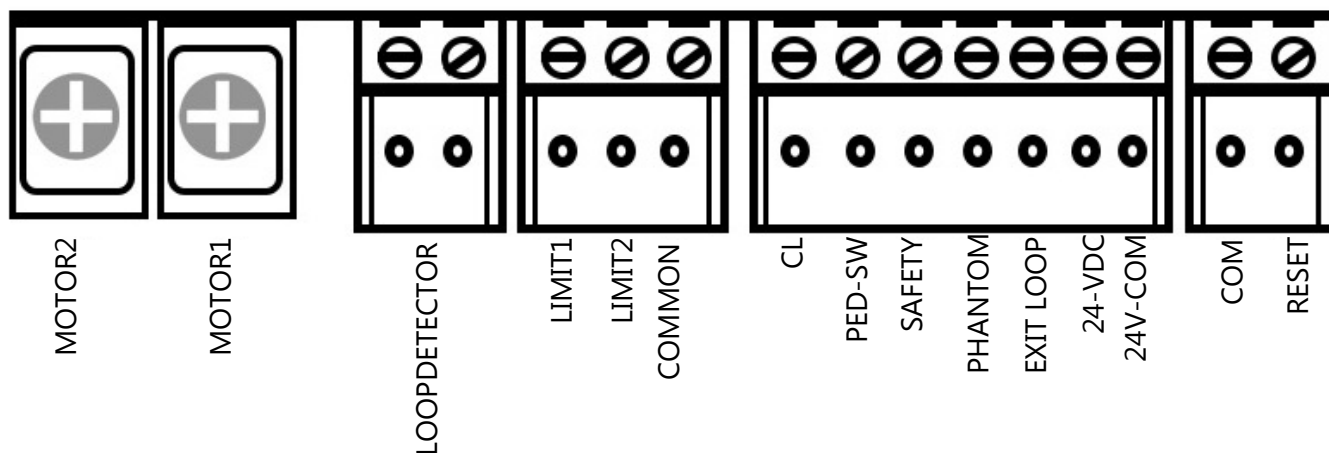
Most accessories can be wired into the relay input.

Use Exit loop or Relay for Normal Open (N/O).

Use the CL Input for Normal Close (N/C).

If using the gate operator to power the accessory, use 24-VDC and the 24V-COM input.

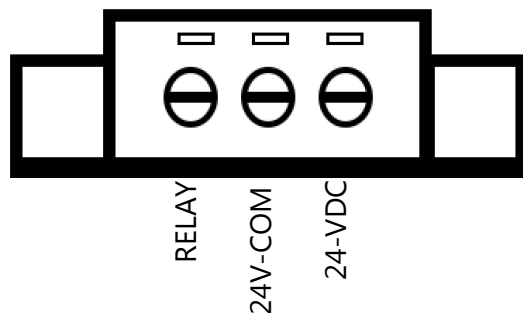
Figure A: Exit Loop Terminals - Located on the right side of the circuit board



Commonly used for:

- Exit Loops / Reverse Loops
- Electric Locks
- Fire Access Box

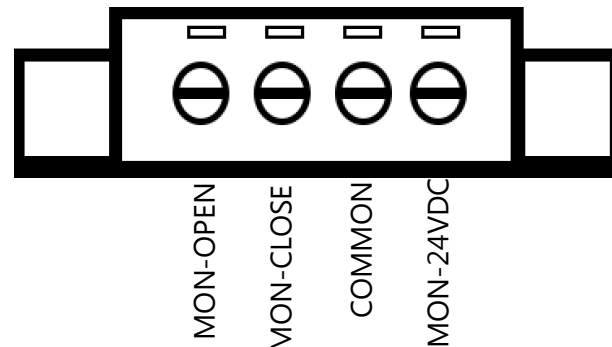
Figure B: Relay Terminals - Located on the outside of the circuit board compartment, top left.



Commonly used for:

- Intercoms/Access Controllers
- Keypads

Figure C: Monitored Terminals - Located on the outside of the circuit board compartment, top left.



Commonly used for:

- Photocell Sensors
- Safety Edges

Accessory Wiring

Electric Lock

Use the Motor2 and Motor1 terminal. These terminals directly supply the electric lock with 12-24VDC electricity right before opening.

Solenoid Lock/Door Strikes

Normal Open (N/O) → Exit Loop
Common → 24V-COM
12-24V DC → 24-VDC

MagLock

A separate transformer is required for a maglock.

Normal Open (N/O) → Exit Loop
Normal Close (N/C) → CL

Push To Exit Button

Normal Open (N/O) → Exit Loop
Normal Close (N/C) → CL

If using the gate operator to power the accessory, use 24-VDC and the 24V-COM input.

Receiver

Relay/Normal Open → Relay
Common → 24V-COM
12-24V DC → 24-VDC

Photocell Sensor (Non-Calimet Brand)

Monitored CLOSE → MON-CLOSE
Common → 24V-COM
12-24VDC → 24-VDC

To monitor the open cycle, use: Monitored OPEN → MON-OPEN

For Calimet brand photocell sensors, see page "Step 6: Installing the Photocell Sensor".

Accessory Wiring

Fire Access Box

Use 14-20 gauge awg wire (not included) and splice (join) with the white and black wires.

Common (White wire) → 24V-COM

N/O (Black wire) → EXIT LOOP

Safety Edge / Edge Sensor

The Calimet CM9-934 Safety Edge is wireless and requires no wiring.

For other brand safety edges, typically, the MON-CLOSE or MON-OPEN input is used depending on if you are monitoring the opening or closing cycle., but generally safety edges are used to monitor the closing cycle as a third form of entrapment protection. Use COMMON and MON-24VDC if the safety edge requires electricity.

Keypad

For the Calimet CM9-535 Wireless keypad, follow the separate keypad instruction manual for installation details.

For wired and non-calimet brand keypads, use a 20 gauge stranded electrical wire and connect using the following:

Normal Open/Relay → Relay

Common → 24V-COM

12-24VDC → 24-VDC

Access Controllers/Intercoms

Use a 20 gauge stranded electrical wire and connect using the following:

Normal Open/Relay → Relay

Common → 24V-COM

12-24VDC → 24-VDC

Alternatively, if the intercom/Access Controller requires a dedicated Normal Open/Normal Close input, use the EXIT LOOP input on the bottom right of the circuit board for Normal Open, and the CL input for Normal Close. The 24-VDC and the 24V-COM can supply electricity to the intercom/Access Controller.

Accessories

Battery

24V Batteries are added to the battery compartment on the bottom of the gate operator. There is a separate battery circuit board that connects to the BAT input on the main gate operator circuit board.

Batteries degrade over time depending on usage. Battery performance may decrease in extremely cold temperatures - performance can be increased by adding insulation to the inside of the gate operator battery compartment or adding a heater. The batteries should be replaced every 3-4 years.

Gate Operator Model Battery Compatibility:

- CM6-ACFP - Not battery compatible
- CM6-DCFP - Included, already installed

Solar Panel

Solar Panels can be wired into the 24VDC SOLAR input on the gate operator circuit board.

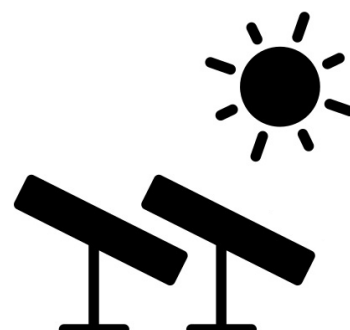
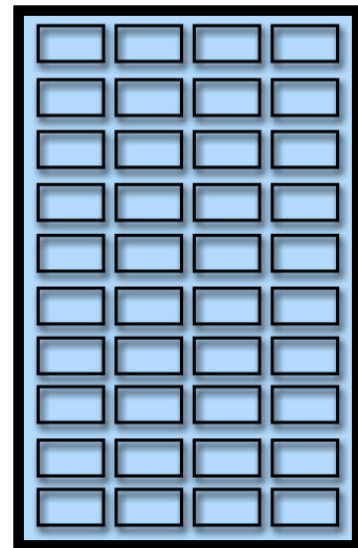
Multiple solar panels may be wired together to charge the battery faster. We recommend two 24VDC solar panels for optimal charging.

Place solar panel at a 45 degree angle, facing SOUTH. Note: optimal angle and orientation may vary based on your location and season.

Make sure the solar panel can receive direct sunlight. If a tree, or other forms of shade blocks the solar panel, move the solar panel to a different location.

Gate Operator Model Solar Compatibility:

- CM6-ACFP - not solar compatible
- CM6-DCFP - solar ready



Circuit Board Light Status Chart

Name	Status/Light
CL	ON when CLOSE input is activated
PED-SW	ON when STAND BY, OFF when the STOP input is activated or foot pedal is pressed down.
SAFETY	ON when Stand By, OFF when SAFETY LOOP input is activated
PHANTOM	ON when incoming signal is detected from a reverse loop (phantom)
EXIT LOOP	ON when EXIT LOOP input is activated
LIMIT1	ON when limit nut has reached the limit 1 switch
LIMIT2	ON when limit nut has reached the limit 2 switch
RADIO	ON when the RADIO input is activated
RESET	ON when circuit board has been RESET
POWER	ON when the gate operator is on standby, blinks when motor is on
B.L-POWER	ON when back up battery is fully charged, blinks when low battery
M/S LINK	Blinks when master/slave communication is active
TIMER	Blinks when TIMER is counting down to close automatically
OPENING	ON when gate is in the open cycle
CLOSING	ON when gate is in the close cycle
MON-FAULT	ON when photo eye has malfunctioned
MON-OPEN	ON when photocell sensor is monitoring the open cycle
MON-CLOSE	ON when photocell sensor is monitoring the close cycle

Alarm

The alarm will sound in these following situations:

- 1. Photocell Sensor Obstruction or Misalignment** -an object has crossed the photocell infrared beam when the gate was closing. If nothing interrupted the beam, the photocell sensor may be misaligned. Align photocell sensor with the reflector on the other side to fix the problem.
- 2. Impact Detection** - The gate operator has a built-in impact sensor called the ERD. If the gate collided with an object, the alarm will sound. If there was no collision, the ERD force may be set too low. Increase the force to fix the issue. Another possible issue is that the chain may be bent or not correctly aligned to the sprocket.
- 3. Low Battery** - Battery is low due to excessive use or multiple consecutive cloudy days (if using solar). Recharge using solar panel or AC electricity. DCFP models only.

Troubleshooting

Problem	Possible Causes	Solution
Gate operator has no power	<ul style="list-style-type: none"> A. Electrical Outage B. Circuit Breaker Tripped C. If using solar panel only (no AC electrical power), battery level may be depleted D. If using solar panel only, battery may need to be replaced E. Conduit and/or power cables are damaged or have corrosion F. Fuse Blown due to electrical overload or faulty wiring G. Circuit Board Malfunction 	<ul style="list-style-type: none"> A. Wait until the power comes back on B. Reset Circuit Breaker C. Recharge the battery by not using the gate operator for 2-3 days, or connect a power cable to the side of the gate operator to recharge the battery. D. Replace battery. E. Replace wiring. F. Replace fuse G. Replace circuit board.
Gate operator does not open	<ul style="list-style-type: none"> A. No Power B. Remote control has no battery. C. Gate is damaged, misaligned, or obstructed. D. Foot pedal is set to manual release E. Circuit board Malfunction 	<ul style="list-style-type: none"> A. Check to make sure electricity is working. If using solar only, give the gate operator 2-3 days to recharge the battery. B. Replace battery. C. Check for any damages, obstruction, or misalignment on the gate. D. Step on the foot pedal and move it to the upper-left. E. Replace circuit board
Gate operator can open but does not close	<ul style="list-style-type: none"> A. Photocell Sensor is not aligned B. Foot pedal is set top manual release C. Open direction is reversed 	<ul style="list-style-type: none"> A. Align photocell sensor with the reflector on the other side. B. Step on the foot pedal and move it to the upper-left. C. Dip Switch #6: OPEN-L/R on the circuit board - set to the opposite position.

Troubleshooting

Problem	Possible Causes	Solution
Gate does not close all the way	A. Limit positions not adjusted properly	A. Readjust limit position by turning the limit cams
Gate operator opens on its own	A. Radio Frequency Interference from another nearby gate operator or garage door operator B. Loop Detector may be too sensitive to environmental vibrations	A. Erase all remote controls on the system by holding the study button on the circuit board for 8 seconds. Manually re-add the remote controls back in by pressing the remote control and the study button until the flashing light turns solid (about 2 seconds) B. Downgrade sensitivity on the loop detector
Gate reverses when traveling	A. Not enough force B. Low Battery	A. Increase force by turning the third (open) and fourth (close) blue knob labeled "ERD" slightly clockwise. B. Charge battery using solar panel or 110VAC electricity

Maintenance

Description	Task	Check every:
Gate	Inspect swivel arm, hinges, posts, and other for wear, damage or misalignment. Lubricate if necessary. There should be no squeaking.	1 month
Photocell Sensor check	Place your hand over the photocell sensor infrared beam when the gate is closing. The gate must stop and reverse.	1 month
Warning Signs	Two signs should be installed. One is visible to people on the outside of the gate, and one is visible to people on the inside of the gate.	1 month
Emergency Release	Turn off power and step down on the foot pedal to move it to the right. Manually push the gate to ensure that it can fully open and close.	2 months
Free Movement Check	Step on foot pedal and move it to the right. Manually push the gate with your hands. Gate should move freely and easily with little to no resistance.	2 month
Force	Gate should reverse when it comes in contact with object. Test both open and close ERD force.	6 months
Accessories	Check all gate operator accessories including remotes, loop detectors, keypad, etc. to make sure they are all operating properly.	1 year
Electrical	Check wiring connections to make sure none are loose or damaged	1 year
Chassis Sleeve Anchors	Check to make sure the anchors are not loose or damaged.	1 year
Battery	Replace battery (DCFP models only)	4 years

MANUFACTURER'S LIMITED WARRANTY

The warrantor, CALIMET CO., INC, warrants the gate operator(s) for a period of three (3) years in commercial installations and for a period of five (5) years in residential installation to be free from defects in motor, gearbox, circuitry, and workmanship. This warranty is limited to two (2) of any combination of repairs or replacement of parts. This warranty applies from the date of purchase to the original owner. Warrantor will repair or replace (at warrantor's sole discretion) any part which it finds to require service, excepting that, this limited warranty does not cover the following: corrosion and, damage or failures resulting from environmental conditions, vandalism, water, lack of proper maintenance, accident, theft, fire, normal wear and tear, misuse, alteration, tampering, improper repair, installation of non-CALIMET approved parts, accessories, or components. This device must be sent to the warrantor at the consumer's expense to:

CALIMET CO., INC.
9949 HAYWARD WAY
SOUTHE EL MONTE, CA 91733

The warrantor will return the repaired or replaced unit to the customer at the consumer's expense. This limited warranty does not cover labor fees for reinstalling a repaired or replaced unit or parts. These warranties are in lieu of all other warranties either expressed or implied, and CALIMET CO., INC shall not be liable for consequential damage. All implied warranties of merchantability and or fitness for a particular purpose are hereby disclaimed and excluded. This limitation is not valid in jurisdictions which do not allow limitation of incidental or consequential damages or limitation of warranty periods. Please complete the registration card and send it by mail within 30 days of purchasing from CALIMET CO., INC. or your INSTALLER. If not registered only a one year warranty on all parts will be provided.

The warranty card must be mailed to the address listed on the card. Alternatively, the warranty can be completed online at <https://calimetco.com/gate-operator-warranty-registration>

CALIMET

9949 Hayward Way South El Monte, CA 91733

Tel: 626-452-9009 Alternate: 626-482-3066 Fax: 626-452-9010

Email: info@calimetco.com

www.calimetco.com

